

Thank you for purchasing a BN Thermic product. Manufactured to a high standard, this product will, if used according to these instructions and properly maintained, give you years of trouble free performance. Please ensure instructions remain with your customer for their reference.



**REGISTER:** PLEASE REGISTER THIS PRODUCT ONLINE TO ACTIVATE YOUR GUARANTEE AT  
[www.bnthermic.co.uk](http://www.bnthermic.co.uk)



**IMPORTANT:** PLEASE READ THESE INSTRUCTIONS, NOTE THE SAFE OPERATIONAL REQUIREMENTS, WARNINGS, AND CAUTIONS. USE THIS PRODUCT CORRECTLY, AND WITH CARE FOR THE PURPOSE FOR WHICH IT IS INTENDED. FAILURE TO DO SO MAY CAUSE DAMAGE AND/OR PERSONAL INJURY AND WILL INVALIDATE THE WARRANTY.

## 1. SAFETY INSTRUCTIONS

### 1.1 ELECTRICAL SAFETY

**WARNING!** It is the responsibility of the owner and the operator to read, understand and comply with the following:

You must check all electrical products, before use, to ensure that they are safe. You must inspect power cables, plugs, sockets and any other connectors for wear or damage. You must ensure that the risk of electric shock is minimised by the installation of appropriate safety devices. A Residual Current Circuit Breaker (RCCB) should be incorporated in the main distribution board. If in any doubt consult a qualified electrician.

You must also read and understand the following instructions concerning electrical safety.

- The Health & Safety at Work Act 1974 makes owners of electrical appliances responsible for the safe condition of those appliances and the safety of the appliance operators. If in any doubt about electrical safety, contact a qualified electrician.
- Installation should always be carried out by a qualified electrician or a competent person in accordance with current electrical regulation.
- Ensure that the insulation of all the cables on the appliance is undamaged and safe, before connecting it to the power supply.
- Ensure that the cables are always protected against short circuit and overload.
- Regularly inspect the power supply cables and plugs etc. for wear or damage and check all connections to ensure that none are loose.
- Important: Ensure that the voltage marked on the appliance matches the power supply to be used and that a correctly rated fuse is fitted.
- DO NOT use worn or damaged cables, plugs or connectors. Immediately have any faulty item repaired or replaced by a qualified electrician.
- The unit should be protected by a suitably rated isolator and fuse or MCB.
- This heater is IP20 rated and is suitable for indoor or under cover use only.
- Do not attach this heater to an extension cord it must be hard wired in position.

### 1.2 GENERAL SAFETY INSTRUCTIONS

- ✓ Remove all packaging and store it away from children, check the package and heater for visible damage or tampering.
- ✓ Familiarise yourself with the applications and limitations of the heater.
- ✓ Ensure the heater is in good order and condition both physically and electrically before use. If in any doubt, do not use the unit and contact your supplier.
- ✓ Only use recommended attachments and parts. To use unauthorised parts may be dangerous and will invalidate your warranty.
- ✓ Keep tools and other items away from the heater when it is in use.
- ✓ Keep children and unauthorised persons away from the heater, as it gets **hot**.
- ✓ Disconnect from mains and allow to cool before attempting any cleaning or maintenance.
- X **DO NOT** use in areas where hazardous gasses or dusts may be present.
- X **DO NOT** locate the heater directly below the power outlet.
- X **DO NOT** disassemble the heater for any reason. This heater must be checked by qualified personnel only.
- X **DO NOT** use this heater to perform a task for which it has not been designed.
- **WARNING!** Ensure you observe the safety distances and mounting heights and there is no possibility of inflammable materials coming into contact.

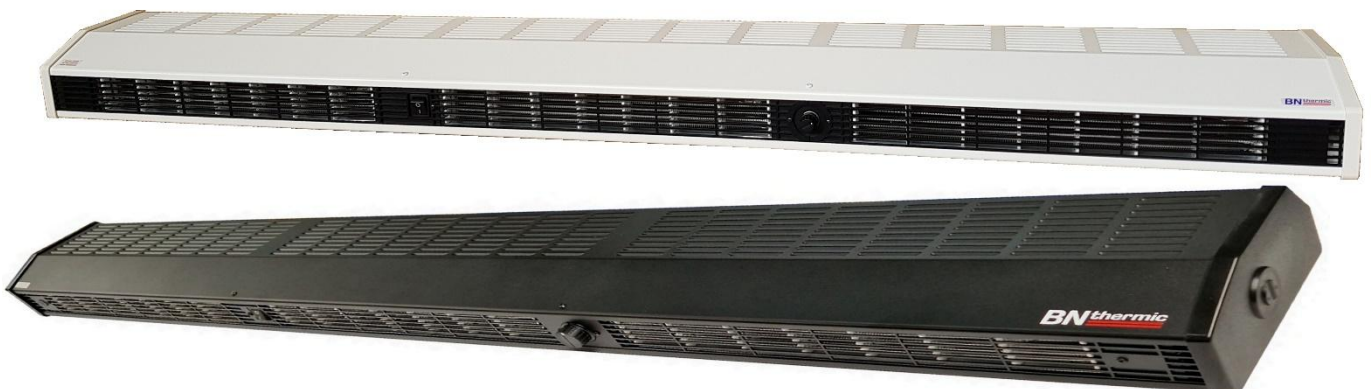

## 2. INTRODUCTION & SPECIFICATION

This heater produces a totally dry heat, no condensation, no gas, no fumes. It reaches maximum heat output within a minute from being turned on. It is quick and easy to install reducing installation costs. Used with the CS-8 controller it can provide low / high heat or fan only settings.

Model	890T / 890TB
Power	9000W
Input supply	230v or 400v 3 Phase
Dimensions (W x D x H)	1620 x 108 x 225mm
Weight	17kg
Recommended Mounting Height	1.8 - 3.0M
Safety Distance from Heater	1.5M
Optional Controller Model No.	CS-8, CS-9



CS-8  
(Optional Extra)

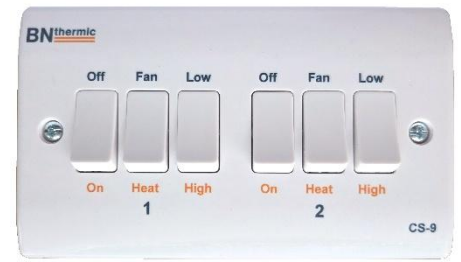

CS-9 Twin Controller  
(Optional Extra)

## 3. LOCATION OF HEATER

When used above a doorway, the heater can be wall or ceiling mounted at a height of 1.8 – 3m above floor level and a minimum of 300mm from adjacent walls.

## 4. MOUNTING INSTALLATION

- ❑ **IMPORTANT!** DO NOT mount heater directly below the power outlet.
- ❑ **IMPORTANT!** Ensure that the mounting surface / ceiling supports are capable of taking the weight of the heater.
- ❑ **IMPORTANT!** Do not allow any object to come closer than 1.5m to the heater outlet.
- ❑ **IMPORTANT!** Always mount the heater horizontal mounting at any other angle will reduce the heater's life and invalidate the guarantee.
- ❑ **IMPORTANT!** The air intake and discharge areas must be kept completely clear for a minimum of 1.5m from the front of the heater.

### 4.1 MOUNTING KIT

The mounting kit supplied with each heater consists of the following items.

1 x Backbone / spacer (approximately the same length as the heater).

2 x Backbone right angled brackets.

2 x Small wall mounting brackets, 2 x Large hanging brackets, 2 x Plastic domes

4 x M2.9 Self Tapping Screws, 6 x M5 x 12mm long pozi drive screws, 2 x M5 Lock washers 4 x M4 Nuts and 4 x M4 Washers.

### 4.2 WALL MOUNTING ABOVE A DOORWAY

Attach the two Small wall mounting brackets to the heater using the Plastic Domes and M2.9 Screws. Make sure both open slots are facing downwards and the brackets face towards the back of the heater (see Pic 1).



Pic 1

Attach the 2 Backbone right angled brackets to the backbone using the M4 nuts and washers (see Pic 2)

Securely attach the Backbone to the wall using suitable fixings (not supplied) The back bone may be removed once the two end brackets have been securely mounted in position. It is only required to obtain the correct spacing of the Backbone right angled brackets. Partially insert M5 screws into the outer two holes in each end of the bracket. Make sure the screw goes all the way through and the thread is just showing the other side (see Pic 2). The heater with its two end brackets should now be slotted onto the fixing bracket (see Pic 3). Now tighten up the four end screws and add an additional M5 centre screw and lock washer into the centre hole at each end of the fixing bracket (see Pic 4). **UNDER NO CIRCUMSTANCES MUST THE HEATER BE TURNED ON IF THESE TWO CENTRE SCREWS AND LOCK WASHERS ARE NOT PRESENT OR TIGHTENED UP.**

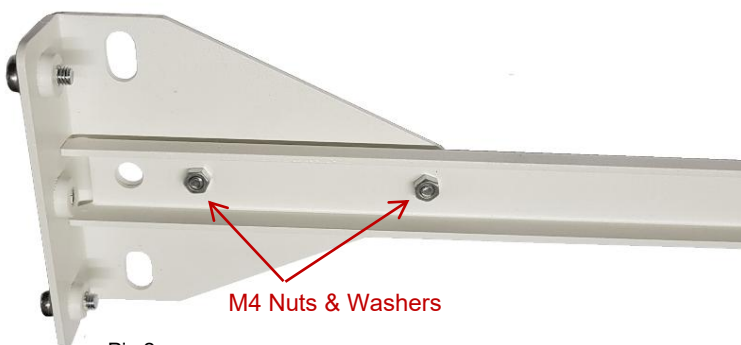

Pic 2



Pic 3



Pic 4

### 4.3 CEILING MOUNTING ABOVE A DOORWAY



Pic 5

You can either use M8 drop rods in the two threaded holes on the top of the heater (drop rods not supplied) or mount directly to the ceiling using the supplied brackets. If mounting using the supplied brackets use the method (section 4.2) with the exception that you use the Large Side Brackets and they must face upwards (see Pic 5). Do not switch on unless the 2 M5 centre screws and lock washers are fitted to the side brackets and tightened. (see Pic 6)



Pic 6

## 5. ELECTRICAL CONNECTIONS

### 5.1 230V SINGLE PHASE – Without controls.

Please make sure you have read the Safety instructions and that you are a suitably qualified electrician before continuing. 6mm<sup>2</sup> PVC cable running in free air (NOT in conduit, walls or any form of enclosure) is rated at 47Amps for short runs. For this reason, we recommend you connect a maximum of 1.5m of 6mm<sup>2</sup> cable to the heater before the isolation switch. From the isolation switch back to the fuse board use 10mm<sup>2</sup> cable.

Drawings show connections inside the black terminal box on the outside of the heater.

**Do NOT use power tools to undo or do up terminal screws.**

Please Note:- Specified cable sizes are for typical installations, correction factors may need to be used when determining actual cable sizes.

The Heater is supplied for single 230v use with the 2 links  present in the power supply box.

#### 230v Standard Connection and Use

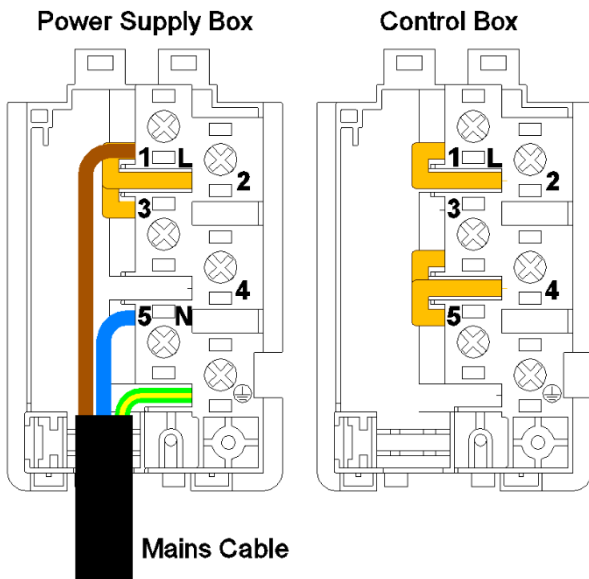

Use 6mm<sup>2</sup> 3 Core Mains Cable (see note above).

Connect Brown wire – Terminal 1 or L.

Connect Blue wire – Terminal 5 or N.

Connect Green / Yellow wire – Terminal E or 

Ensure the 3 links  are in position in the Control Box as shown in drawing to the left. Links should be between terminals 1 and 2, 3 and 4, 4 and 5.

#### De-Rating the Heater

If you wish to permanently de-rate the heater from 9kW to 6kW remove the link  between terminal 4 and terminal 5 in the Control Box. Ensure you tighten up the screws after removing the link. See drawing to the right.

PLEASE CHECK ALL CONNECTIONS BEFORE TURNING ON AS INCORRECT WIRING IS NOT COVERED BY THE GUARANTEE

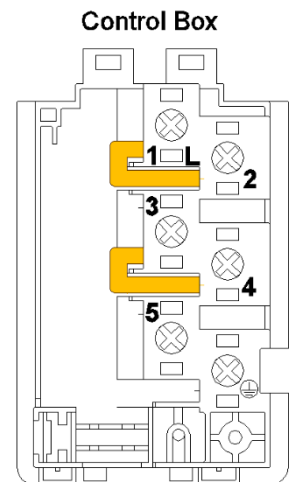

Heater de-rated to 6kW

**5.2 400V THREE PHASE – Without controls.**



Please make sure you have read the Safety instructions and that you are a suitably qualified electrician before continuing. Drawings show connections inside the black terminal box on the outside of the heater.

**Do NOT use power tools to undo or do up terminal screws.**

Please Note:- Specified cable sizes are for typical installations, correction factors may need to be used when determining actual cable sizes.

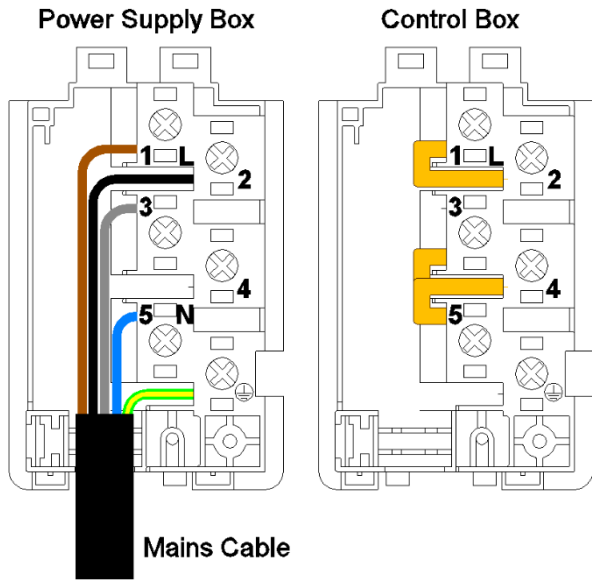
400v Three Phase Standard Connection and Use



Ensure there are no links  present in the power supply box  
 Use minimum 1.5mm<sup>2</sup> 5 Core Mains Cable (see note above).  
 Connect Brown wire – Terminal 1 or L.  
 Connect Black wire – Terminal 2.  
 Connect Grey wire – Terminal 3.  
 Connect Blue wire – Terminal 5 or N.  
 Connect Green / Yellow wire – Terminal E or 

Ensure the 3 links  are in position in the Control Box as shown in drawing to the left. Links should be between terminals 1 and 2, 3 and 4, 4 and 5.

De-Rating the Heater

If you wish to permanently de-rate the heater from 9kW to 6kW remove the link  between terminal 4 and terminal 5 in the Control Box. Ensure you tighten up the screws after removing the link. See drawing to the right.

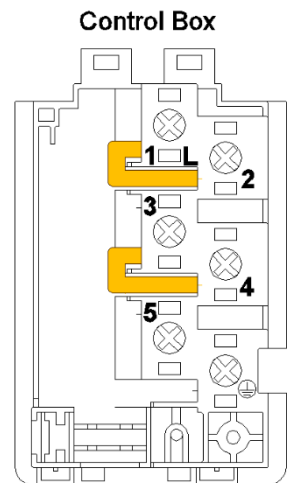

**Heater de-rated to 6kW**

PLEASE CHECK ALL CONNECTIONS BEFORE TURNING ON AS INCORRECT WIRING IS NOT COVERED BY THE GUARANTEE

## 6. CONNECTING CONTROLS TO THE HEATER

6.1 Adding a CS-8 or CS-9 Controller, provides on / off / high heat / low heat / fan only settings. If connecting to CS-9 follow instructions inside CS-9 packaging box.

Please make sure you have read the Safety instructions and that you are a suitably qualified electrician before continuing.

Drawings show connections inside the black terminal box on the outside of the heater and the inside of the CS-8 Controller.

**Do NOT use power tools to undo or do up terminal screws.**

### Standard Connection using CS-8 Controller

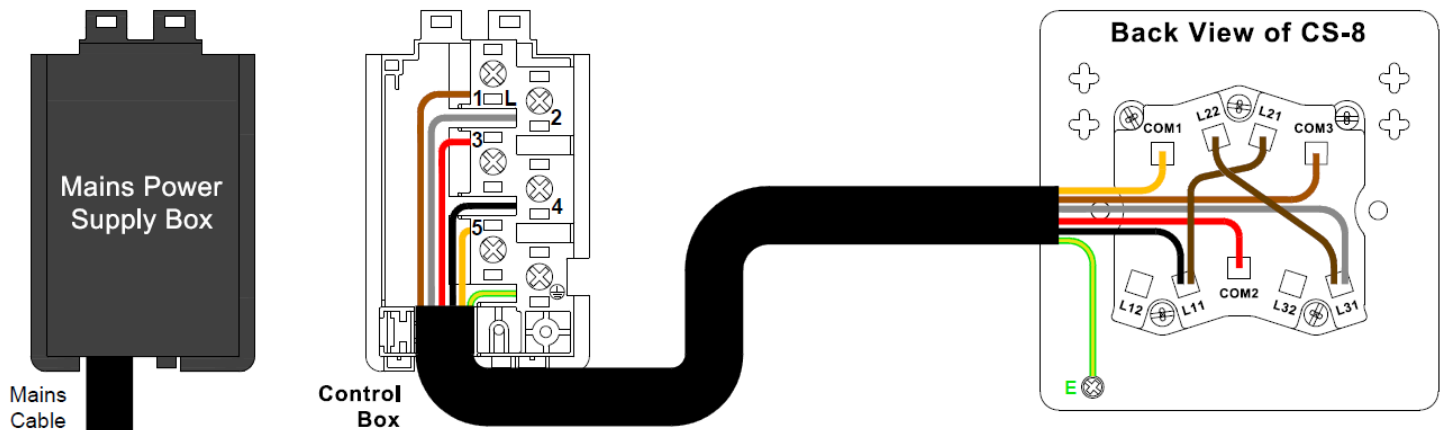

Use 0.75mm<sup>2</sup> 6 Core Cable to connect the heater to the CS-8 Controller.

Remove any links  that may be present in heater Control Box between terminals 1,2,3,4 or 5.

Heater (Control Box) to CS-8 Controller Cable– (Colours for reference only)

**Move the Dark Brown link cable from COM2 to L22 you should now have a link wire between L21 and L11 and another between L22 and L31 (Shown above).**

Connect Brown wire – Terminal 1 or L of heater and Top Terminal COM3 of CS-8.

Connect Grey wire – Terminal 2 of heater and Terminal L31 of CS-8.

Connect Red wire – Terminal 3 of heater and Terminal COM2 of CS-8.

Connect Black wire – Terminal 4 of heater and Terminal L11 of CS-8.

Connect Yellow wire – Terminal 5 of heater and Terminal COM1 of CS-8.

Connect Green / Yellow wire – Terminal E or  of heater and earth connection on CS-8.

PLEASE CHECK ALL CONNECTIONS BEFORE TURNING ON AS INCORRECT WIRING IS NOT COVERED BY THE  
GUARANTEE

## 7. CHANGE MODE OF OPERATION

The heater has two modes of operation to suit different applications.

These two modes are selected by a switch on the back of the heater.

### **Mode I**

With the switch on the back of the heater in the "I" position both the heater elements and the fan turn on and off with the thermostat. This mode is best used when using the heater as a space heater or overdoor heater with a large area to heat but may give long periods of on / off switching when the heater is used as an overdoor heater.

### **Mode II**

With the switch on the back of the heater in the "II" position the fan runs continuously and only the heating elements go on and off with the thermostat.

If you use this heater as an overdoor heater, in a confined space or within 300mm of a ceiling, we recommend you use this mode of operation.

Please Note:- This switch was previously located on the top of the heater.



## 8. CONTROL

Standard control is by the on/off switch located towards the left-hand side of the heater on the front grill and by adjusting the electronic thermostat knob located on the right-hand side of the heater on the front grill.

## 9. MAINTENANCE

**Note:** Before examining or carrying out any maintenance ensure the heater has cooled down and is disconnected from the mains supply.

The heaters are intended to operate for many years, problem free. All moving parts are factory lubricated and therefore should require no service. Maintenance is limited to keeping both the inlet and outlet areas free from any accumulation of dust or any other foreign materials. This is especially important immediately before the heating season. Any dust build up can be loosened using a brush and a vacuum cleaner applied to the airways to ensure completed removal of any dust. When the heater is first turned on after cleaning an unusual odour may be noted this is due to the dust particles which inevitably will be disturbed and will be burnt off from the heating element.

If in any doubt always consult a qualified electrician for advice.

## 10. AUTO CUT OUT / FUSE REPLACEMENT

This heater is fitted with a semi-automatic safety device to prevent overheating. The device will isolate the heating element while the fan continues to operate. Should this occur, disconnect the heater from the mains supply for a minimum of 5 minutes, check and remove any foreign materials around the airways. If the heater fails to operate or the safety cut out operates again, turn off the heater and contact a qualified electrician.

The Heater is protected by a fuse. The fuse holder is located on the front face of the unit. Should the fuse fail, replace with another 3.15A or 3A fuse. Fuse is 6.3mm dia x 32mm long. If this replacement fuse fails seek professional help.

Please Note:- That previously this fuse holder was located on the top of the heater.

**NOTE:** It is our policy to continually improve products and as such we reserve the right to alter data, specifications and component parts without prior notice.



### WEEE REGULATIONS:

This appliance bears the symbol of the crossed waste bin. This indicates that, at the end of its useful life, it must not be disposed of as domestic waste, but must be taken to a collection centre for waste electrical and electronic equipment. It is the user's responsibility to dispose of this appliance through the appropriate channels. Failure to do so may incur penalties established by laws governing waste disposal.

**IMPORTANT:** No liability is accepted for incorrect use of this product.

**WARRANTY:** Your BN Thermic product is guaranteed for one year from date of purchase. We will repair or replace at our discretion any part found to be defective. We cannot assume any consequential liability. This guarantee in no way prejudices your rights under common law and is offered as an addition to consumer liability rights.

**REGISTER:** Activate your warranty by registering online at [www.bnthermic.co.uk](http://www.bnthermic.co.uk) and retain this installation data for future reference.

BN Thermic Ltd,  
34 Stephenson Way,  
Crawley, RH10 1TN  
Tel: 01293 547361  
[sales@bnthermic.co.uk](mailto:sales@bnthermic.co.uk)  
[www.bnthermic.co.uk](http://www.bnthermic.co.uk)

890TINS-v01-6