

**BN** *thermic*

*Call the heater people*







commercial & industrial



# ELECTRIC HEATERS



**UK**  
Manufacturing

**2024**

UNDERFLOOR HEATING		Mats	M Series	6-7
		Cables	EHC	8-9
		Foil Mats	F Series	10-11
		Thermostats	Various	12-13
		Mirror Demister Pads	MD	14-15

HEATING CABLES		Self-Regulating Cables	CRJ	16-19
		Pipe Freeze Kit	PW	20-21

FAN HEATERS		Ceiling Grid Heaters	SCH/XC	22-27
		Surface Mount Heaters	SMH/XS	28-33
		Overdoor Heaters	800 Series/XD	34-39
		Recessed Heaters	RH/XR	40-45
		Commercial Air Curtains	CA/XA	46-51
		Industrial Heaters	OUH	52-55
		Destratification Units	DSU	56-59

CONVECTION HEATERS		Pew Heaters	PH	60-63
		Industrial Tubular Heaters	SWD	64-67
		ATEX Tubular Heaters	TX	68-69
RADIANT HEATERS		All Black Radiant Heaters	ETH	70-73
		Patio Heaters	HWP	74-79
		Quartz Halogen Heaters	HN	80-87
		Quartz Halogen Control Box	HC	88-91
		Ceramic Heaters	CH	92-95
		Ceiling Panels	RP	96-99
		Radiant Cassettes	ESP	100-103
		Longwave Heater Control Box	PC	104-107
CONTROLS		Thermostats	Various	108-118
		SystemX	Various	119
		Timers	Various	120-121
		Switches	Various	122-123
		Miscellaneous	Various	124-127
PRICES		2024 Price List		128-131

# ABOUT US

## BN Thermic Ltd

BN Thermic is a family owned and operated UK manufacturer of commercial and industrial electric heaters. We operate out of our HQ in Crawley, West Sussex and distribute heaters via UK electrical wholesalers. Our business is built on our four key values – quality, honesty, helpfulness and attention to detail.

Whether you are a contractor, wholesaler or end user, our goal is to deliver quality heaters next day and back you up with our expert design advice.

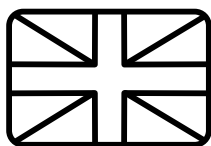

### Quality

We manufacturer and supply quality products. All our heaters are tested electrically and mechanically before leaving our premises.



### Honesty

BN Thermic is an independent family business that relies on repeat customers. Honesty is a key value to us.



### Helpfulness

Our staff always look to help customers throughout the sales process from pre construction right through to after sales.



### Attention to Detail

From manufacturing products to designing heating schemes, attention to detail is at the core of BN Thermic.



## OUR COMMITMENT TO UK MANUFACTURING

### UK Manufacturing

BN Thermic is a proud UK manufacturer and has been for almost 20 years. By hand assembling heaters in house, our customers know they are installing a heater that has been rigorously tested and manufactured to the highest standard. Manufacturing our own heaters also allows us to monitor and keep good stock levels at all time.

Our commitment to UK manufacturing also means we can operate more sustainably by keeping our carbon footprint as low as possible, all whilst supporting both local and national economies.



# UK Manufacturing



Next Day Delivery



Purchase from  
Electrical Wholesaler

# UNDERFLOOR HEATING MATS

## What is an M Series Underfloor Heating Mat?

A lifetime warranty underfloor heating mat that creates a luxurious warm floor and provides efficient room heating. Compatible with all floor types and all room types including wet rooms.



## Key Features

- Lifetime warranty
- Twin core cable assembled onto a fibreglass web
- 3m power lead
- Continuous earth braided wire and fixing tape
- The mat can be cut and manipulated to suit room dimensions
- Typically select a mat approximately 10% smaller than the free floor area
- Wide choice of thermostats (see pages 12-13)



### ENERGY SAVING TIP

Laying F-Board insulation boards will greatly increase the economy of your system.

## Standard Output Mats (150W/m<sup>2</sup>)

Suitable as a main source of heating in most rooms

Model	Heated Area (m <sup>2</sup> )	Mat Size (m)	kW	List Price
M150-005	0.5	1.0 x 0.5	0.07	£63.00
M150-010	1.0	2.0 x 0.5	0.15	£70.00
M150-015	1.5	3.0 x 0.5	0.22	£93.00
M150-020	2.0	4.0 x 0.5	0.30	£124.00
M150-025	2.5	5.0 x 0.5	0.37	£132.00
M150-030	3.0	6.0 x 0.5	0.45	£155.00
M150-035	3.5	7.0 x 0.5	0.52	£177.00
M150-040	4.0	8.0 x 0.5	0.60	£210.00
M150-045	4.5	9.0 x 0.5	0.67	£222.00
M150-050	5.0	10 x 0.5	0.75	£242.00
M150-060	6.0	12 x 0.5	0.90	£288.00
M150-070	7.0	14 x 0.5	1.05	£313.00
M150-080	8.0	16 x 0.5	1.20	£331.00
M150-090	9.0	18 x 0.5	1.35	£362.00
M150-100	10	20 x 0.5	1.50	£389.00
M150-110	11	22 x 0.5	1.65	£442.00
M150-120	12	24 x 0.5	1.80	£484.00
M150-140	14	28 x 0.5	2.10	£536.00
M150-160	16	32 x 0.5	2.40	£610.00

## High Output Mats (200W/m<sup>2</sup>)

Recommended for conservatories

Model	Heated Area (m <sup>2</sup> )	Mat Size (m)	kW	List Price
M200-010	1.0	2.0 x 0.5	0.20	£77.00
M200-015	1.5	3.0 x 0.5	0.30	£103.00
M200-020	2.0	4.0 x 0.5	0.40	£131.00
M200-030	3.0	6.0 x 0.5	0.60	£163.00
M200-040	4.0	8.0 x 0.5	0.80	£215.00
M200-050	5.0	10 x 0.5	1.00	£257.00
M200-060	6.0	12 x 0.5	1.20	£314.00
M200-070	7.0	14 x 0.5	1.40	£357.00
M200-080	8.0	16 x 0.5	1.60	£436.00
M200-090	9.0	18 x 0.5	1.80	£473.00
M200-100	10	20 x 0.5	2.00	£585.00

## Insulation Boards

Limits downward heat loss

Model	Dimensions (mm)	Area Covered (m <sup>2</sup> )	List Price
F-Board-6	1200 x 600 x 6	0.72	£26.00
F-Board-10	1200 x 600 x 10	0.72	£29.00

## Repair Kit

Emergency use

Model	Description	List Price
EHM-R-Kit	Cable Repair Kit	£41.00



# UNDERFLOOR HEATING CABLE

## What is an EHC Underfloor Heating Cable?

A lifetime warranty underfloor heating cable that creates a luxurious warm floor and provides efficient room heating. Compatible with all floor types and ideally suited to irregularly shaped rooms.



### Key Features

- Lifetime warranty
- Twin core cable
- 3m power lead
- Continuous earth braided wire and fixing tape
- Wide choice of thermostats (see pages 12-13)



#### ENERGY SAVING TIP

Laying F-Board insulation boards will greatly increase the economy of your system.



## Heating Cables

Model	kW	Heated Area (m <sup>2</sup> )	Cable Length (m)	List Price
EHC-012	0.12	0.7 – 1.0	11	£75.00
EHC-020	0.20	1.1 – 1.5	19	£92.00
EHC-025	0.25	1.6 – 2.0	24	£102.00
EHC-032	0.32	2.1 – 2.5	32	£117.00
EHC-040	0.40	2.6 – 2.9	37	£128.00
EHC-045	0.45	3.0 – 3.3	46	£148.00
EHC-052	0.52	3.4 – 3.8	50	£151.00
EHC-060	0.60	3.9 – 4.5	64	£187.00
EHC-075	0.75	4.6 – 6.0	76	£200.00
EHC-095	0.95	6.1 – 7.5	87	£235.00
EHC-110	1.10	7.6 – 8.5	115	£292.00
EHC-130	1.30	8.6 – 10.0	131	£322.00
EHC-170	1.70	10.1 – 13.0	159	£397.00
EHC-200	2.00	13.1 – 15.5	194	£516.00

## Insulation Boards

Limits downward heat loss

Model	Dimensions (mm)	Area Covered (m <sup>2</sup> )	List Price
F-Board-6	1200 x 600 x 6	0.72	£26.00
F-Board-10	1200 x 600 x 10	0.72	£29.00

## Repair Kit

Emergency use

Model	Description	List Price
EHM-R-Kit	Cable Repair Kit	£41.00



# UNDERFLOOR HEATING FOIL MATS

## What is an F Series Underfloor Heating Mat?

An underfloor heating mat that creates a luxurious warm floor and provides efficient room heating. Designed specifically for quick and easy installation under laminate and engineered wood floors.



## Key Features

- 10 year warranty
- Installed without adhesives or compounds
- Twin core cable sandwiched between layers of aluminium
- 3m power lead
- The mat can be cut and manipulated to suit room dimensions
- Typically select a mat approximately 10% smaller than the free floor area
- I-Board insulation limits downward heat loss and must be laid first
- Wide choice of thermostats (see pages 12-13)



### ENERGY SAVING TIP

Control with a 7-day programmable thermostat to keep your running costs to an absolute minimum.

## Foil Heating Mats (140W/m<sup>2</sup>)

Model	Heated Area (m <sup>2</sup> )	Mat Size (m)	kW	List Price
F140-010	1.0	2.0 x 0.5	0.14	£89.00
F140-015	1.5	3.0 x 0.5	0.21	£125.00
F140-020	2.0	4.0 x 0.5	0.28	£146.00
F140-030	3.0	6.0 x 0.5	0.42	£194.00
F140-040	4.0	8.0 x 0.5	0.56	£255.00
F140-050	5.0	10 x 0.5	0.70	£296.00
F140-060	6.0	12 x 0.5	0.84	£345.00
F140-070	7.0	14 x 0.5	0.98	£412.00
F140-080	8.0	16 x 0.5	1.12	£445.00
F140-090	9.0	18 x 0.5	1.26	£508.00
F140-100	10	20 x 0.5	1.40	£554.00
F140-120	12	24 x 0.5	1.68	£647.00
F140-140	14	28 x 0.5	1.96	£796.00

## Insulation and Fixing Tape

Model	Description	Area Covered (m <sup>2</sup> )	List Price
I-Pack-6	Insulation/underlay 19-pack (6mm thick)	9.76	£48.00
I-Board-6	Insulation/underlay individual (6mm thick) 600 x 856mm	0.51	£6.50
LHT	Fixing tape for I-Board	10	£16.00
AL-50	Fixing tape for foil mat	10	£17.00



Next Day Delivery



Purchase from  
Electrical Wholesaler

# UNDERFLOOR HEATING THERMOSTATS



B16C



T16CW



T16CB



T16CS

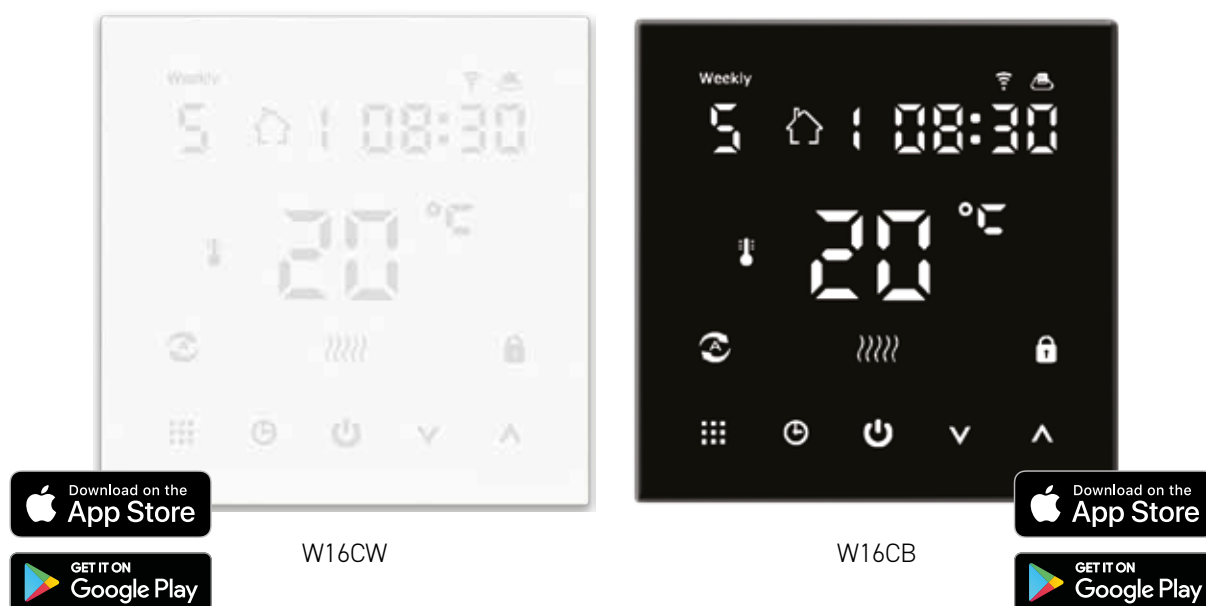

- Function** Accurate electronic temperature control for electric underfloor heating
- Applications** Suitable for use with all BN Thermic underfloor heating systems
- Features**
- 16A switching
  - Air/floor or floor only control
  - Floor probe supplied as standard
  - Free app for Wi-Fi models

## Thermostats

Model	Description	Details	Price
B16C	Basic programmable thermostat	page 108	£69.00
W16CW	Touch screen/Wi-Fi thermostat (white)	page 108	£133.00
W16CB	Touch screen/Wi-Fi thermostat (black)	page 108	£133.00
T16CW	Touch screen thermostat (white)	page 109	£185.00
T16CB	Touch screen thermostat (black)	page 109	£198.00
T16CS	Touch screen thermostat (silver)	page 109	£198.00
CXSIP	Optional IP65 air temperature sensor for all underfloor heating thermostats (ideal for bathrooms)	page 109	£44.00
RB26	Relay box (26A) enables thermostat to switch up to 6kW	page 124	£101.00



Next Day Delivery

Purchase from  
Electrical Wholesaler

# MIRROR DEMISTER PADS

## What is a Mirror Demister Pad?

An economic pad that demists mirrors in domestic and commercial bathrooms. A great luxurious addition to any new bathroom fit out.

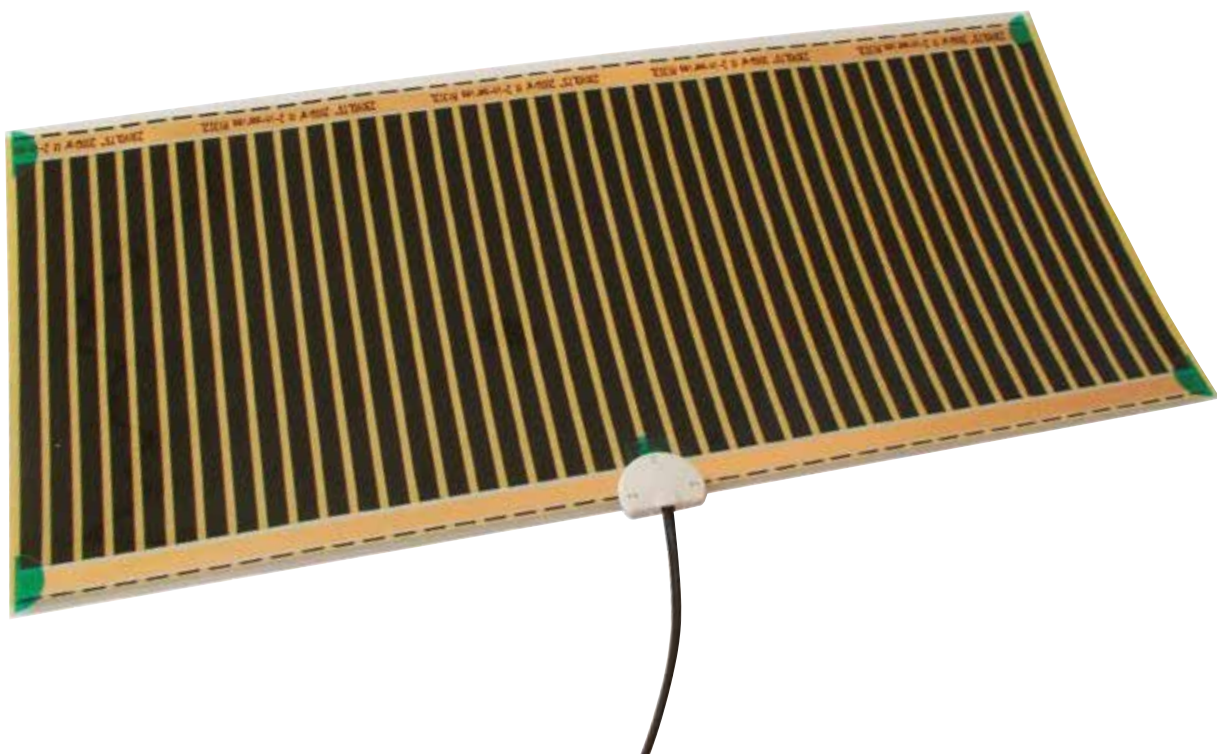

## Key Features

- 100% effective in a little over 2 minutes
- Protects an area approximately 20% larger than the pad itself
- Peel-off adhesive backing for quick and easy installation
- 1m long power lead
- Multiple pads can be used on one mirror
- 230V supply
- Class II IP44
- Suitable for bathroom zones 2 and 3



### ENERGY SAVING TIP

Wiring your pad into your lighting circuit ensures the pad is not left on when your room is unoccupied

## Demister Pads - 300mm wide

Model	Watts	Length (mm)	List Price
MD3-29	16	290	£55.00
MD3-49	27	490	£63.00
MD3-73	40	730	£72.00
MD3-97	54	970	£81.00
MD3-125	69	1250	£93.00
MD3-149	83	1490	£97.00

## Demister Pads - 500mm wide

MD5-29	27	290	£60.00
MD5-49	46	490	£71.00
MD5-73	69	730	£81.00
MD5-97	92	970	£93.00
MD5-125	119	1250	£107.00
MD5-149	142	1490	£116.00

## Demister Pads - 700mm wide

MD7-29	38	290	£66.00
MD7-49	65	490	£77.00
MD7-73	98	730	£90.00
MD7-97	131	970	£105.00
MD7-125	169	1250	£124.00
MD7-149	201	1490	£134.00



Next Day Delivery

Purchase from  
Electrical Wholesaler

# SELF-REGULATING HEAT CABLES

## What is CRJ Self Regulating Heat Cable ?

A cable which prevents water from freezing in metal and plastic pipes. This clever cable adjusts its output depending on your pipe's temperature which reduces running costs. The cable is commonly installed on sprinkler systems, in farms and commercial premises. It is often referred to as 'trace heating cable.'



## Key Features

- Supplied by the metre – order as much or as little as required
- Power consumption decreases as pipe temperature increases
- Can be cut to length on site
- Full length earth braid and thermoplastic outer jacket
- Installed onto pipe under insulation



### ENERGY SAVING TIP







Control your cable with a frost thermostat to ensure your cable only energizes when the ambient temperature drops below your desired temperature.

## Cables

Model	W/m	Voltage	Maximum Exposure Temperature (°C)		Max Circuit Length	List Price/m (under 50m)	List Price/m (50m+)
			On	Off			
CRJ-10	10	230	85	85	176m	£16.00	£15.00
CRJ-25	25	230	85	85	120m	£28.00	£27.00



## Accessories

Model	Description	List Price
 CRJ-T1	Termination Kit (one per circuit) uses shrink on material. Prepares cable for electrical connection and seals the far end.	£23.00
 CRJ-S	Splice/T Kit – one for every splice or T joint.	£24.00
 PF-T	Fixing Tape (33m x 19mm) for fixing cable to pipe – max temp 80°C	£5.00
 AL-50	Aluminium Tape (45m x 50mm) – for wrapping plastic pipes before installing cable or for fixing cable to pipe - max temp 110°C (note maximum exposure temp of cable)	£17.00
 PF-L	Caution Label (10 pack) apply to outside of insulation for safety	£9.50
 FST3-EX	Frost Thermostat Outdoor Use IP66 (20A) – see page 111	£133.00

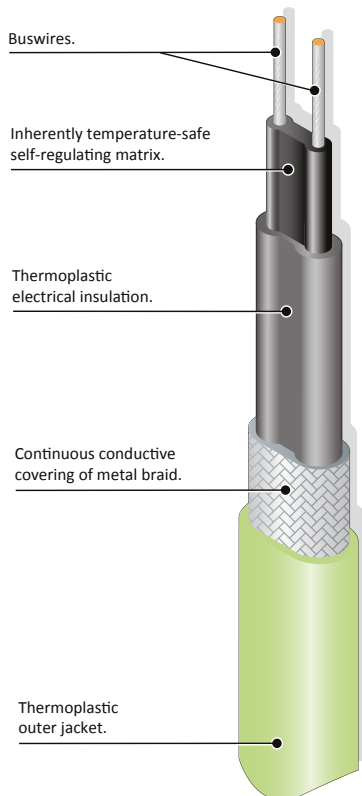

## Pipe Freeze Protection – Selection Table

- Minimum ambient: -15°C
- Mineral wool insulation
- Cable installed in a straight line
- Frost thermostat always recommended

Pipe outside diameter	Insulation thickness (mm)		
	12	25	50
12mm	CRJ-10	CRJ-10	CRJ-10
25mm	CRJ-10	CRJ-10	CRJ-10
50mm	CRJ-25	CRJ-10	CRJ-10
75mm	CRJ-25	CRJ-25	CRJ-10
100mm	-	CRJ-25	CRJ-10
150mm	-	CRJ-25	CRJ-25





## Water Treatment Facility

**Location:** Multiple UK Locations

**Installed:** CRJ-25 Cable



Next Day Delivery

Purchase from  
Electrical Wholesaler

## PIPE FREEZE PROTECTION KITS

### What is a PW Pipe Freeze Protection Kit ?

An economic 'plug and play' kit that prevents water from freezing in plastic and metal pipes. These kits are most commonly installed on condensing boiler drain pipes but have a wide range of possible applications.



### Key Features

- Built-in thermostat
- 1.5m power lead with 3-pin plug

### Selection

- Installed onto pipe under insulation (20mm max)
- Straight run protects pipes up to 50mm dia
- Can be wound in an evenly spaced helix





#### ENERGY SAVING TIP

Ensure the blue thermostat is installed under your lagging to ensure accurate temperature control

## Pipe Freeze Protection Kits

Model	Watts	Volts	Heated Length (m)	List Price
PW-01	12	230	1	£102.00
PW-02	24	230	2	£111.00
PW-03	36	230	3	£123.00
PW-04	48	230	4	£129.00
PW-06	72	230	6	£140.00
PW-10	136	230	10	£145.00
PW-14	152	230	14	£150.00
PW-21	281	230	21	£151.00
PW-30	337	230	30	£180.00
PW-42	490	230	42	£208.00

## Accessories

Model	Description	List Price
 PF-L	Caution Label (10 pack)	£9.50
 PF-T	Fixing Tape (33m x 19mm)	£5.00
 AL-50	Aluminium Tape (45m x 50mm) for wrapping plastic pipes before cable installation	£17.00



Next Day Delivery

Purchase from  
Electrical Wholesaler

# CEILING GRID HEATERS

## What is a Ceiling Grid Heater ?

A staple product when space heating commercial premises such as shops, cafes and schools. Ceiling heaters free up valuable wall space and fit easily into a 600 x 600 grid ceiling.



## Key Features

- Designed to rest in the T bar of a 600 x 600 suspended ceiling
- White egg-crate grille supplied with every heater
- Low profile design – only 200mm clearance required above grid
- Models with a 'T' suffix have adjustable electronic thermostat
- Can be controlled by CS-7 controller and/or suitably rated thermostat (3kW: 16A, 4.5kW: 20A, 6kW: 10A)
- For multi-heater installations see SystemX (page 24-25)











### ENERGY SAVING TIP

Control with a 7-day programmable thermostat to keep your running costs to an absolute minimum.

## SCH Ceiling Grid Fan Heaters

Model	kW	Built-in Thermostat	List Price
SCHG-30	3.0	No	£393.00
SCHG-30T	3.0	Yes	£568.00
SCHG-45	4.5	No	£460.00
SCHG-45T	4.5	Yes	£605.00
SCHG-60	6.0	No	£650.00

## Controls

	Description	Model	Details	List Price
	Switch (on/off/high heat/low heat/fan only)	CS-7	Page 122	£98.00
	Electronic programmable thermostat 16A (recessed)*	RD16	Page 112	£65.00
	Electronic programmable thermostat 16A*	RT16	Page 112	£144.00
	Electronic programmable thermostat 26A*	RT26	Page 113	£177.00
	Wi-Fi electronic thermostat 16A (recessed - free app)*	WD16	Page 113	£130.00
	Wi-Fi electronic thermostat 16A (free app)*	WT16	Page 114	£222.00
	Wi-Fi electronic thermostat 26A (free app)*	WT26	Page 114	£269.00
	Adjustable room thermostat 16A	RST3-IN	Page 110	£60.00
	Tamperproof room thermostat 16A	RST3-TP	Page 110	£80.00

\*Tamperproof function available on these models

## Technical

	kW		Volts	Airflow (m <sup>3</sup> /h)	dB*@2m	Recommended Mounting Height(m)		Weight (kg)
	High	Low				Min	Max	
	3.0	2.0	230	245	56	2.4	3.0	9.0
	4.5	2.25	230	345	60	3.0	4.5	10
	6.0	4.0	230	490	58	2.4	3.0	13

\*Noise levels are factory tested not laboratory tested



Next Day Delivery



Purchase from Electrical Wholesaler

# SystemX CEILING GRID FAN HEATERS

## What is a SystemX Ceiling Grid Heater ?

A staple product when heating larger commercial premises with 600 x 600 grid ceilings. Multiple SystemX ceiling grid heaters can be daisy chained from one simple to use controller as per the diagram below. Control connections are all made with Cat5 cable making for a quick, error free install.

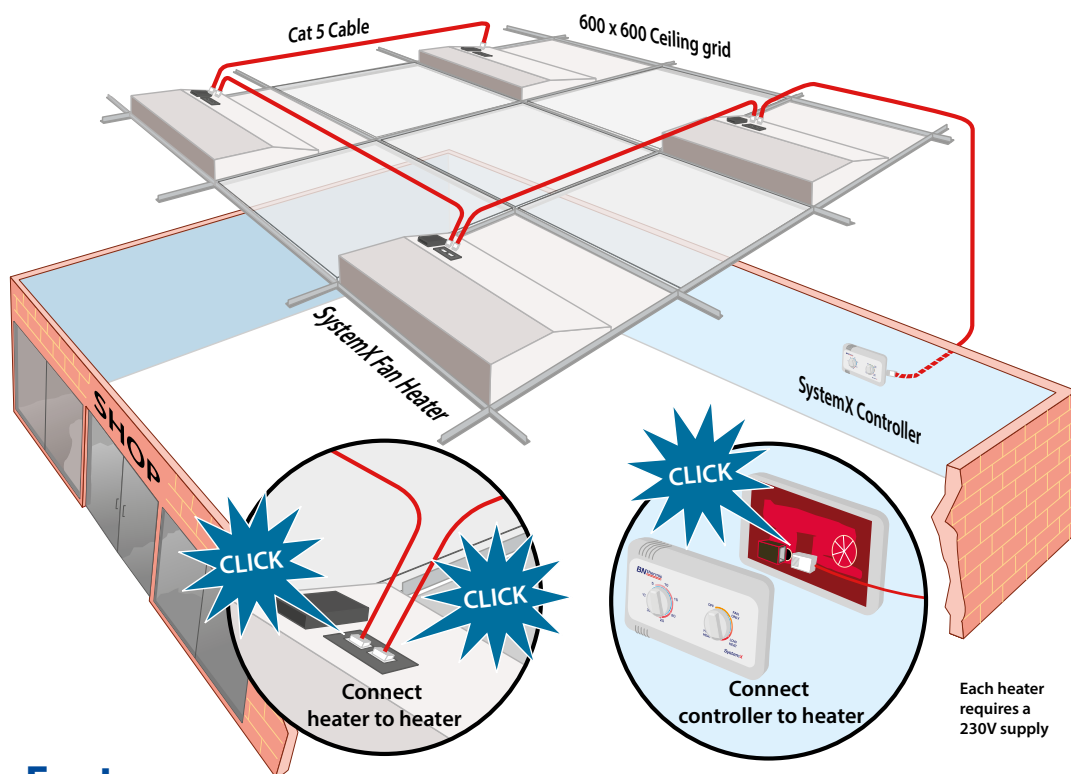

## Key Features

- Control up to 12 heaters from a single point
- Designed to rest in the T bar of a 600 x 600 suspended ceiling
- White egg-crate grille supplied as standard
- Low profile design – only 200mm clearance required above grid
- All control connections by Cat5 cable for quick error-free installation
- Controllers do not require their own 230V supply
- BMS compatible using CX-BMS module
- Can be controlled in a group with any other style of SystemX heater











**ENERGY SAVING TIP**  
Control with a 7-day programmable thermostat to keep your running costs to an absolute minimum.



## SystemX Ceiling Grid Fan Heaters

Model	kW	List Price
XC-30	3.0	£523.00
XC-45	4.5	£606.00
XC-60	6.0	£789.00

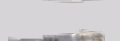
## SystemX Control Components

	Description	Model	Details	List Price
	Controller with thermostat On/off/low/high/fan only settings	CX1	Page 119	£144.00
	Controller with tamper resistant thermostat On/off/low/high/fan only settings	CX2	Page 119	£147.00
	Controller - manual On/off/low/high/fan only settings	CX3	Page 119	£146.00
	Controller with digital programmable thermostat	CX6	Page 119	£253.00
	BMS module for use with volt-free signal	CX-BMS	Page 119	£137.00
	Optional remote sensor for use with CX1, CX2 or CX6 controllers	CX5	Page 119	£42.00
	Cat5 cable terminated 5m	DX05	-	£10.00
	Cat5 cable terminated 10m	DX10	-	£15.00
	Cat5 cable terminated 20m	DX20	-	£23.00
	Cat5 cable joiner	JX1	-	£5.50

## Technical

	kW		Volts	Airflow (m <sup>3</sup> /h)	dB*@2m	Recommended Mounting Height(m)		Weight (kg)
	High	Low				Min	Max	
	3.0	2.0	230	245	56	2.4	3.0	9.0
	4.5	2.25	230	345	60	3.0	4.5	10
	6.0	4.0	230	490	58	2.4	3.0	13

\*Noise levels are factory tested not laboratory tested



## Art Gallery

**Location:** Margate, Kent

**Installed:** 1 x 6kW Ceiling Grid Fan Heater



## Supersport Ltd

**Location:** Tunstall, Stoke-on-Trent

**Installed:** 4 x 3kW Ceiling Grid Fan Heaters



# SURFACE MOUNT CEILING HEATERS

## What is a Surface Mount Ceiling Heater ?

A robust heater that's designed to space heat commercial premises with solid ceilings such as shops, cafes and schools. Ceiling heaters free up valuable wall space and can be surface mounted or suspended. Now with a choice of black or white finishes.



## Key Features

- Compact design – only 152mm high
- Keyhole screw fixing or suspend from drop rods (M6 threaded holes provided)
- Models with a 'T' suffix have adjustable electronic thermostat
- Can be controlled by CS-7 controller and/or suitably rated thermostat (3kW: 16A, 4.5kW: 20A, 6kW: 10A)
- For multi-heater installations see SystemX (page 30-31)











**ENERGY SAVING TIP**  
Control with a 7-day programmable thermostat to keep your running costs to an absolute minimum.

## SMH Surface Mount Ceiling Heaters

Model	kW	Finish	Built-in Thermostat	List Price
SMH-30	3.0	White	No	£410.00
SMH-30B	3.0	Black	No	£410.00
SMH-30T	3.0	White	Yes	£550.00
SMH-45	4.5	White	No	£450.00
SMH-45T	4.5	White	Yes	£590.00
SMH-60	6.0	White	No	£680.00

## Controls

	Description	Model	Details	List Price
	Switch (on/off/high heat/low heat/fan only)	CS-7	Page 122	£98.00
	Electronic programmable thermostat 16A (recessed)*	RD16	Page 112	£65.00
	Electronic programmable thermostat 16A*	RT16	Page 112	£144.00
	Electronic programmable thermostat 26A*	RT26	Page 113	£177.00
	Wi-Fi electronic thermostat 16A (recessed - free app)*	WD16	Page 113	£130.00
	Wi-Fi electronic thermostat 16A (free app)*	WT16	Page 114	£222.00
	Wi-Fi electronic thermostat 26A (free app)*	WT26	Page 114	£269.00
	Adjustable room thermostat 16A	RST3-IN	Page 110	£60.00
	Tamperproof room thermostat 16A	RST3-TP	Page 110	£80.00

\*Tamperproof function available on these models

## Technical

kW		Volts	Airflow (m <sup>3</sup> /h)	dB*@2m	Recommended Mounting Height(m)		Dimensions(mm)			Weight (kg)
High	Low				Min	Max	W	D	H	
3.0	2.0	230	245	56	2.4	3.0	575	392	152	8.0
4.5	2.25	230	345	60	3.0	4.5	575	392	152	11.0
6.0	4.0	230	490	58	2.4	3.0	575	592	152	12.5

\*Noise levels are factory tested not laboratory tested



Next Day Delivery



Purchase from  
Electrical Wholesaler

# SystemX SURFACE MOUNT CEILING HEATERS

## What is a SystemX Surface Mount Ceiling Heater ?

A robust heater that's designed to space heat larger commercial premises with solid ceilings. Multiple SystemX surface mount ceiling heaters can be daisy chained from one simple to use controller as per diagram below. Control connections are all made with Cat5 cable making for a quick, error free install.



## Key Features

- Control up to 12 heaters from a single point
- Compact design – only 152mm high
- Keyhole screw fixing or suspend from drop rods (M6 threaded holes provided)
- All control connections by Cat5 cable for super quick error-free installation
- Controllers do not require their own 230V supply
- BMS compatible using CX-BMS module
- Can be controlled in a group with any other style of SystemX heater













### ENERGY SAVING TIP

Control with a 7-day programmable thermostat to keep your running costs to an absolute minimum.

## SystemX Surface Mount Ceiling Heaters

Model	kW	Finish	List Price
XS-30	3.0	White	£567.00
XS-30B	3.0	Black	£567.00
XS-45	4.5	White	£609.00
XS-60	6.0	White	£806.00

## SystemX Control Components

Description	Model	Details	List Price
 Controller with thermostat On/off/low/high/fan only settings	CX1	Page 119	£144.00
 Controller with tamper resistant thermostat On/off/low/high/fan only settings	CX2	Page 119	£147.00
 Controller - manual On/off/low/high/fan only settings	CX3	Page 119	£146.00
 Controller with digital programmable thermostat	CX6	Page 119	£253.00
 BMS module for use with volt-free signal	CX-BMS	Page 119	£137.00
 Optional remote sensor for use with CX1, CX2 or CX6 controllers	CX5	Page 119	£42.00
 Cat5 cable terminated 5m	DX05	-	£10.00
 Cat5 cable terminated 10m	DX10	-	£15.00
 Cat5 cable terminated 10m (black)	DX10B	-	£15.00
 Cat5 cable terminated 20m	DX20	-	£23.00
 Cat5 cable joiner	JX1	-	£5.50

## Technical

kW		Volts	Airflow (m <sup>3</sup> /h)	dB*@2m	Recommended Mounting Height(m)		Dimensions(mm)			Weight (kg)
High	Low				Min	Max	W	D	H	
3.0	2.0	230	245	56	2.4	3.0	575	392	152	8.0
4.5	2.25	230	345	60	3.0	4.5	575	392	152	11.0
6.0	4.0	230	490	58	2.4	3.0	575	592	152	12.5

\*Noise levels are factory tested not laboratory tested



### Stores Area

**Location:** Swansea, Wales

**Installed:** 2 x 3kW Surface Mount Fan Heater in black finish





## The Rural Auction Centre

**Location:** Milnthorpe, Cumbria

**Installed:** 7 x 6kW Surface Mount Ceiling Heaters



Next Day Delivery

Purchase from  
Electrical Wholesaler

# OVERDOOR HEATERS

## What is an Overdoor Heater ?

A discreet heater that lives above doors and creates a warm welcome for staff and customers in commercial applications such as shops, cafes and entrance areas. Now with a choice of black and white finish.

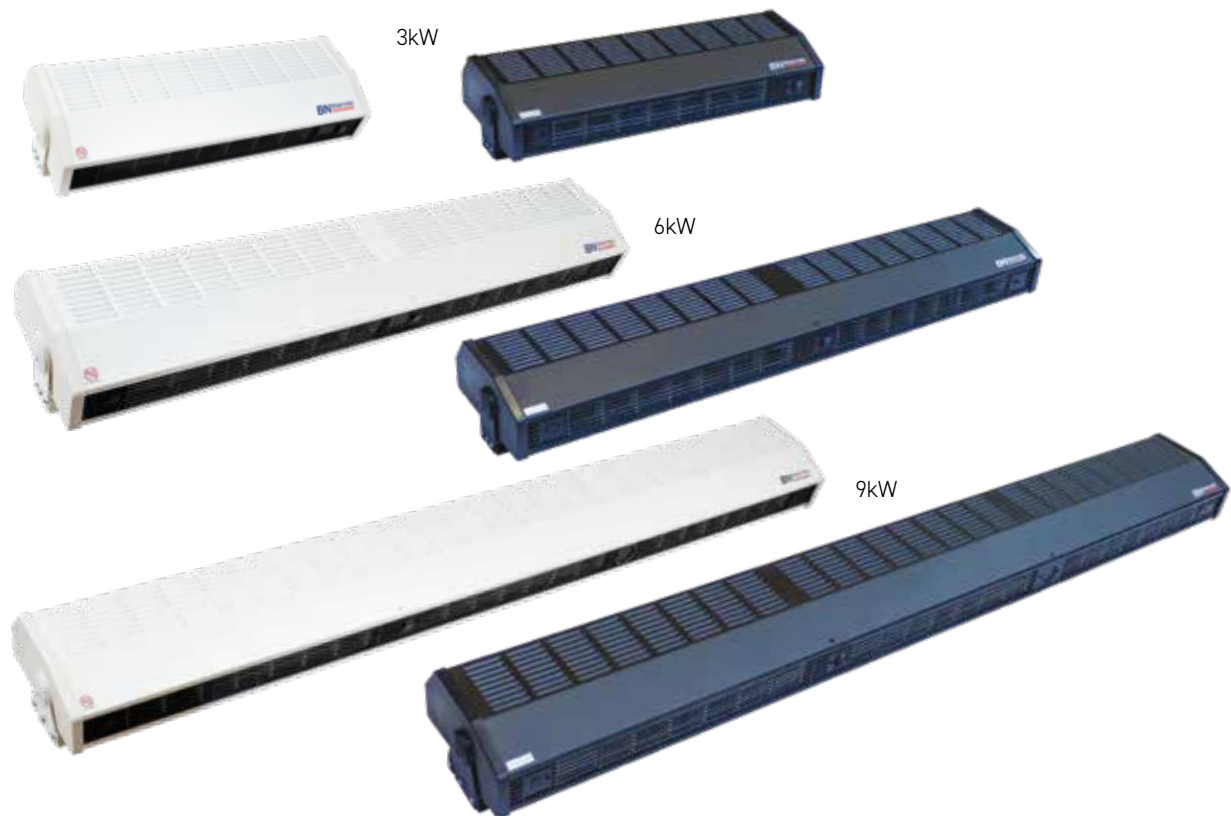

## Key Features

- Dual function bracket for overdoor or space heating (overdoor only for 9kW heater)
- M8 threaded holes for drop rod suspension
- Models with a 'T' suffix have adjustable electronic thermostat
- Can be controlled by CS-7 controller and/or suitably rated thermostat (3kW: 16A, 6kW: 10A, 9kW: 3A)
- For multi-heater installations see SystemX (page 36-37)



### ENERGY SAVING TIP

Installing a CS-7 switch gives you a low heat option which reduces your electricity consumption (ideal for warmer months)







## 800 Series Overdoor Heaters – White Finish

Model	kW	Finish	Built in thermostat	List Price
830	3	White	No	£395.00
830T	3	White	Yes	£520.00
860	6	White	No	£638.00
860T	6	White	Yes	£775.00
890	9	White	No	£1015.00
890T	9	White	Yes	£1135.00

## 800 Series Overdoor Heaters – Black Finish

Model	kW	Finish	Built in thermostat	List Price
830B	3	Black	No	£395.00
830TB	3	Black	Yes	£520.00
860B	6	Black	No	£638.00
860TB	6	Black	Yes	£775.00
890B	9	Black	No	£1015.00
890TB	9	Black	Yes	£1135.00

## Controls

	Description	Model	Details	List Price
	Switch (on/off/high heat/low heat/fan only)	CS-7	Page 122	£98.00
	Electronic programmable thermostat 16A (recessed)*	RD16	Page 112	£65.00
	Electronic programmable thermostat 16A*	RT16	Page 112	£144.00
	Electronic programmable thermostat 26A*	RT26	Page 113	£177.00
	Adjustable room thermostat 16A	RST3-IN	Page 110	£60.00
	Tamperproof room thermostat 16A	RST3-TP	Page 110	£80.00

\*Tamperproof function available on these models

## Technical

kW		Volts	Airflow (m <sup>3</sup> /h)	dB* @2m	Recommended Mounting Height(m)		Dimensions(mm)			Weight (kg)
High	Low				Min	Max	W	D	H	
3.0	2.0	230	245	56	1.8	3.0	635	108	225	7.0
6.0	4.0	230	490	58	1.8	3.0	1105	108	225	11.5
9.0	6.0	230 or 400/3N	735	58	1.8	3.0	1620	108	225	17

\*Noise levels are factory tested not laboratory tested



Next Day Delivery



Purchase from  
Electrical Wholesaler

# SystemX OVERDOOR HEATERS

## What is a SystemX Overdoor Heater ?

A discreet heater that lives above doors and creates a warm welcome for staff and customers in commercial applications such as shops, cafes and entrance areas. Multiple SystemX overdoor heaters can be daisy chained from one simple to use controller as per diagram below. Control connections are all made with Cat5 cable making for a quick, error free install.



## Key Features

- Control up to 12 heaters from a single point
- Dual function bracket for overdoor or space heating (overdoor only for 9kW heater)
- M8 threaded holes for drop rod suspension
- All control connections by Cat5 cable for super quick error-free installation
- Controllers do not require their own 230V supply
- BMS compatible using CX-BMS module
- Can be controlled in a group with any other style of SystemX heater











**ENERGY SAVING TIP**  
Installing a CX1, 2 or 3 controller gives you a low heat option which reduces your electricity consumption (ideal for warmer months)

## SystemX Overdoor Heaters

Model	kW	Finish	List Price
XD-30	3	White	£590.00
XD-60	6	White	£859.00
XD-90	9	White	£1,122.00

## SystemX Control Components

	Description	Model	Details	List Price
	Controller with thermostat On/off/low/high/fan only settings	CX1	Page 119	£144.00
	Controller with tamper resistant thermostat On/off/low/high/fan only settings	CX2	Page 119	£147.00
	Controller - manual On/off/low/high/fan only settings	CX3	Page 119	£146.00
	Controller with digital programmable thermostat	CX6	Page 119	£253.00
	BMS module for use with volt-free signal	CX-BMS	Page 119	£137.00
	Optional remote sensor for use with CX1, CX2 or CX6 controllers	CX5	Page 119	£42.00
	Cat5 cable terminated 5m	DX05	-	£10.00
	Cat5 cable terminated 10m	DX10	-	£15.00
	Cat5 cable terminated 20m	DX20	-	£23.00
	Cat5 cable joiner	JX1	-	£5.50

## Technical

kW		Volts	Airflow (m <sup>3</sup> /h)	dB* @2m	Recommended Mounting Height(m)		Dimensions(mm)			Weight (kg)
High	Low				Min	Max	W	D	H	
3.0	2.0	230	245	56	1.8	3.0	635	108	225	7.0
6.0	4.0	230	490	58	1.8	3.0	1105	108	225	11.5
9.0	6.0	230 or 400/3N	735	58	1.8	3.0	1620	108	225	17

\*Noise levels are factory tested not laboratory tested



## Brewdog

**Location:** Central London

**Installed:** 1 x 6kW Overdoor Heater in black finish



## The Original Factory Shop

**Location:** Llandudno, Wales

**Installed:** 1 x 6kW Overdoor Heater



## RECESSED FAN HEATERS

### What is an Recessed Fan Heater ?

A discreet heater that lives in plasterboard ceilings and provides space heating for commercial premises such as shops, cafes and schools. Recessed ceiling heaters free up valuable wall space and are often used as overdoor heaters when ceiling height is minimal.

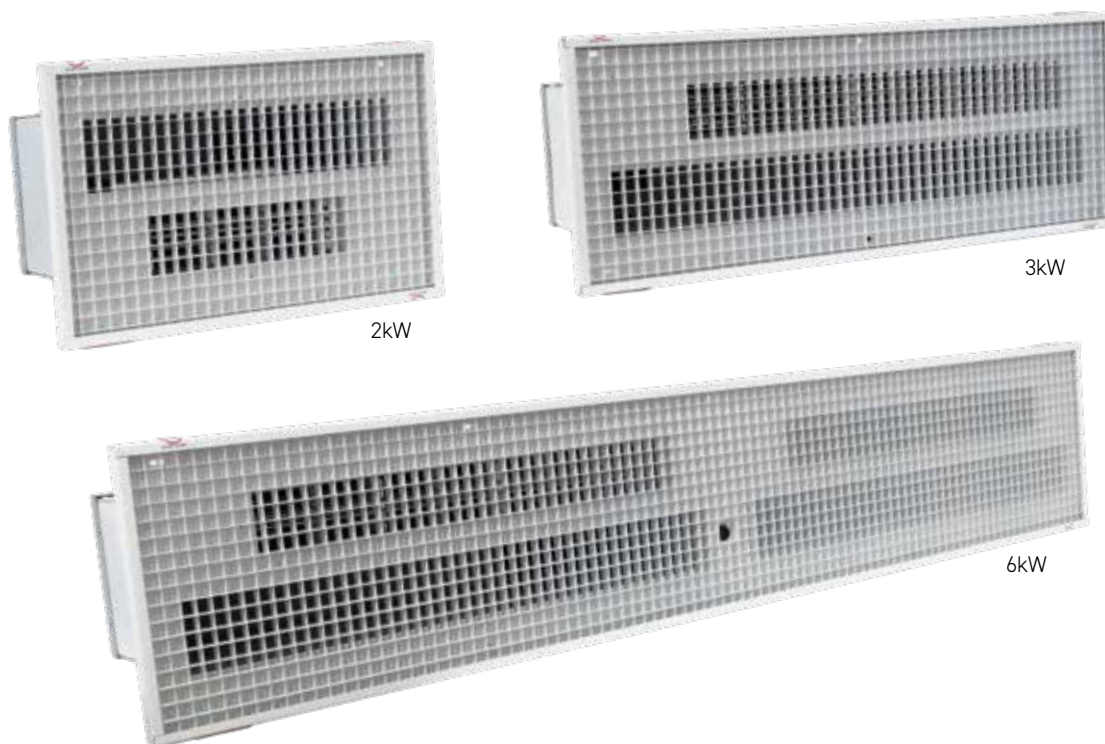

### Key Features

- Air inlet and outlet through front panel
- Simple fixing through front face of heater
- Only 200mm clearance required above ceiling
- Suitable for vertical or horizontal air discharge
- Can be controlled by CS-7 controller and/or suitably rated thermostat (2kW: 10A, 3kW: 16A, 6kW: 10A)
- For multi-heater installations see SystemX (page 42-43)



#### ENERGY SAVING TIP









Installing a CS-7 switch gives you a low heat option which reduces your electricity consumption (ideal for warmer months)



## RH Recessed Fan Heaters

Model	kW	List Price
RH-20	2.0	£329.00
RH-30	3.0	£435.00
RH-60	6.0	£802.00

## Controls

	Description	Model	Details	List Price
	Switch (on/off/high heat/low heat/fan only)	CS-7	Page 122	£98.00
	Electronic programmable thermostat 16A (recessed)*	RD16	Page 112	£65.00
	Electronic programmable thermostat 16A*	RT16	Page 112	£144.00
	Electronic programmable thermostat 26A*	RT26	Page 113	£177.00
	Wi-Fi electronic thermostat 16A (recessed - free app)*	WD16	Page 113	£130.00
	Wi-Fi electronic thermostat 26A (free app)*	WT26	Page 114	£269.00
	Adjustable room thermostat 16A	RST3-IN	Page 110	£60.00
	Tamperproof room thermostat 16A	RST3-TP	Page 110	£80.00

\*Tamperproof function available on these models

## Dimensions

kW	A (mm)	B (mm)	Aperture Size (mm)	Insert Clearance (mm)
2.0	363	307	315 x 150	200
3.0	597	550	560 x 150	200
6.0	1198	1138	1148 x 150	200

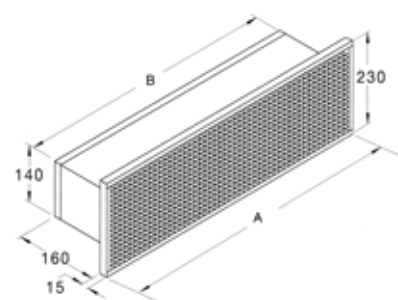

## Technical

kW	Volts		Airflow (m³/h)	dB* @2m	Recommended Mounting Height (m)		Weight (kg)
	High	Low			Min	Max	
2.0	1.0	230	132	50	1.8	2.4	4.0
3.0	2.0	230	245	56	1.8	3.0	6.0
6.0	4.0	230	490	58	1.8	3.0	12

\*Noise levels are factory tested not laboratory tested



Next Day Delivery

Purchase from  
Electrical Wholesaler

# SystemX RECESSED FAN HEATERS

## What is a SystemX Recessed Fan Heater ?

A discreet heater that lives in plasterboard ceilings and provides space heating for commercial premises such as shops, cafes and schools. Multiple SystemX recessed heaters can be daisy chained from one simple to use controller as per diagram below. Control connections are all made with Cat5 cable making for a quick, error free install.

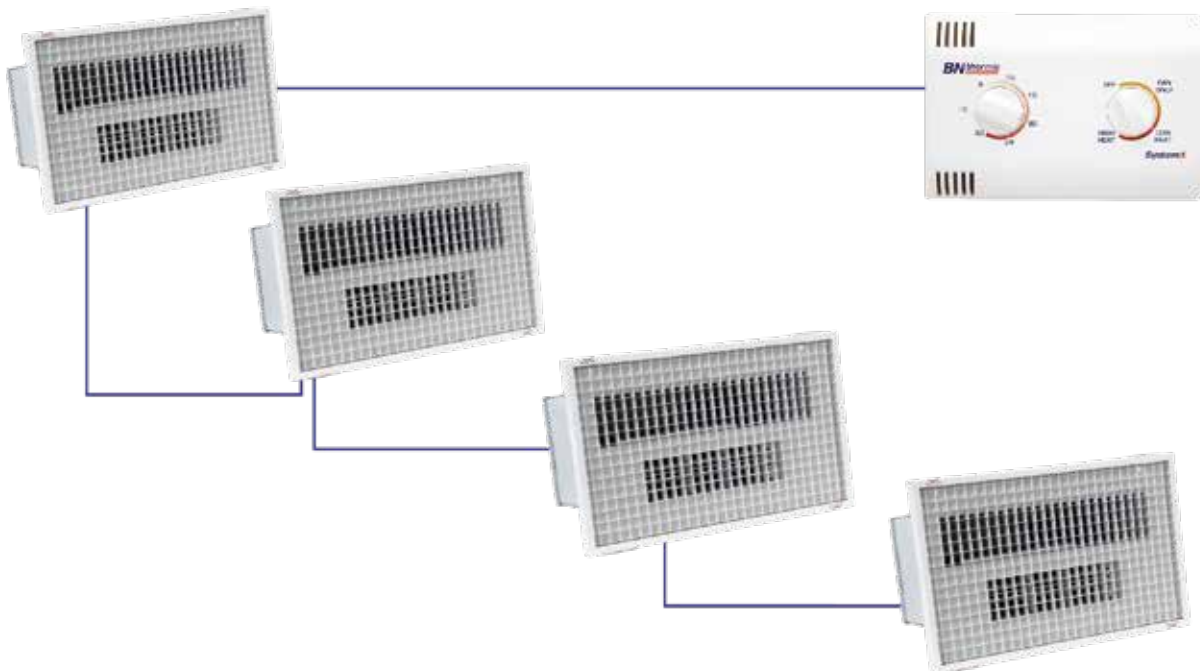

## Key Features

- Control up to 12 heaters from a single point
- Air inlet and outlet through front panel
- Simple fixing through front face of heater
- Only 200mm clearance required above ceiling
- Suitable for vertical or horizontal air discharge
- All control connections by Cat5 cable for quick error-free installation
- Controllers do not require their own 230V supply
- BMS compatible using CX-BMS module
- Can be controlled in a group with any other style of SystemX heater













**ENERGY SAVING TIP**  
Installing a CX1, 2 or 3 controller gives you a low heat option which reduces your electricity consumption (ideal for warmer months)

## SystemX Recessed Heaters

Model	kW	List Price
XR-20	2.0	£480.00
XR-30	3.0	£546.00
XR-60	6.0	£925.00

## SystemX Control Components

Description	Model	Details	List Price
 Controller with thermostat On/off/low/high/fan only settings	CX1	Page 119	£144.00
 Controller with tamper resistant thermostat On/off/low/high/fan only settings	CX2	Page 119	£147.00
 Controller - manual On/off/low/high/fan only settings	CX3	Page 119	£146.00
 Controller with digital programmable thermostat	CX6	Page 119	£253.00
 BMS module for use with volt-free signal	CX-BMS	Page 119	£137.00
 Optional remote sensor for use with CX1, CX2 or CX6 controllers	CX5	Page 119	£42.00
 Cat5 cable terminated 5m	DX05	-	£10.00
 Cat5 cable terminated 10m	DX10	-	£15.00
 Cat5 cable terminated 20m	DX20	-	£23.00
 Cat5 cable joiner	JX1	-	£5.50

## Dimensions

kW	A (mm)	B (mm)	Aperture Size (mm)	Insert Clearance (mm)
2.0	363	307	315 x 150	200
3.0	597	550	560 x 150	200
6.0	1198	1138	1148 x 150	200

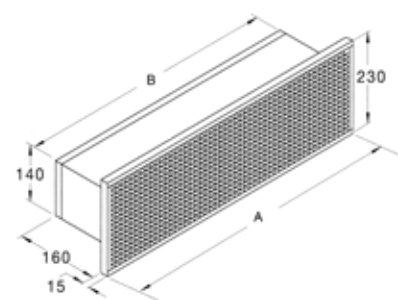

## Technical

kW	Volts	Airflow (m <sup>3</sup> /h)	dB* @2m	Recommended Mounting Height (m)		Weight (kg)
				High	Low	
2.0	230	132	50	1.8	2.4	4.0
3.0	230	245	56	1.8	3.0	6.0
6.0	230	490	58	1.8	3.0	12

\*Noise levels are factory tested not laboratory tested



### Mind Charity Shop

**Location:** Camden, London

**Installed:** 3 x 3kW Recessed Heaters



## Charity Shop

**Location:** Tunbridge Wells, Kent

**Installed:** 1 x 6kW Recessed Heater



# COMMERCIAL AIR CURTAINS

## What is a Commercial Air Curtain ?

A discreet heater that lives above doors and aims to reduce heat loss from 'open door' commercial premises such as shops, cafes and entrance areas. Commercial air curtains have a higher air velocity than overdoor heaters and create a more efficient air screen.



## Features

- Bracket for wall or ceiling mounting
- M8 threaded holes for drop rod suspension
- Can be controlled by CS-7 controller and/or suitably rated thermostat
- For multi air curtain installations see SystemX (page 48-49)









### ENERGY SAVING TIP

Installing a CS-7 switch gives you a low heat option which reduces your electricity consumption (ideal for warmer months)

## CA Commercial Air Curtains

Model	kW	Length (mm)	List Price
CAS-30	3.0	635	£570.00
CAS-45	4.5	635	£582.00
CAD-60	6.0	1105	£875.00
CAD-90	9.0	1105	£909.00
CAT-90	9.0	1620	£1088.00
CAT-135	13.5	1620	£1200.00
CAH-180	18.0	2085	£1,603.00

## Controls

	Description	Model	Details	List Price
	Switch (on/off/high heat/low heat/fan only)	CS-7	Page 122	£98.00
	Electronic programmable thermostat 16A*	RT16	Page 112	£144.00
	Electronic programmable thermostat 26A*	RT26	Page 113	£177.00
	Wi-Fi electronic thermostat 16A (free app)*	WT16	Page 114	£222.00
	Wi-Fi electronic thermostat 26A (free app)*	WT26	Page 114	£269.00
	Adjustable room thermostat 16A	RST3-IN	Page 110	£60.00
	Tamperproof room thermostat 16A	RST3-TP	Page 110	£80.00

\*Tamperproof function available on these models

## Technical

Model	kW		Volts	Airflow (m³/h)	dB* @2m	Recommended Mounting Height(m)		Dimensions (mm)			Weight (kg)
	High	Low				Min	Max	W	D	H	
CAS	3.0	2.0	230	345	60	2.5	3.5	635	108	225	8.5
CAS	4.5	2.25	230	345	60	2.5	3.5	635	108	225	8.5
CAD	6.0	4.0	230	690	62	2.5	3.5	1105	108	225	13.5
CAD	9.0	4.5	230	690	62	2.5	3.5	1105	108	225	13.5
CAT	9.0	6.0	230 or 400/3N	1035	62	2.5	3.5	1620	108	225	19
CAT	13.5	6.75	400/3N	1035	62	2.5	3.5	1620	108	225	19
CAH	18.0	12.0	400/3N	1440	66	2.5	3.5	2085	108	225	22.5

\*Noise levels are factory tested not laboratory tested



# SystemX COMMERCIAL AIR CURTAINS

## What is a SystemX Commercial Air Curtain ?

A discreet heater that lives above doors and aims to reduce heat loss from 'open door' commercial premises such as shops, cafes, entrance areas and hotels. Multiple SystemX commercial air curtains can be daisy chained from one simple to use controller as per diagram below. Control connections are all made with Cat5 cable making for a quick, error free install.

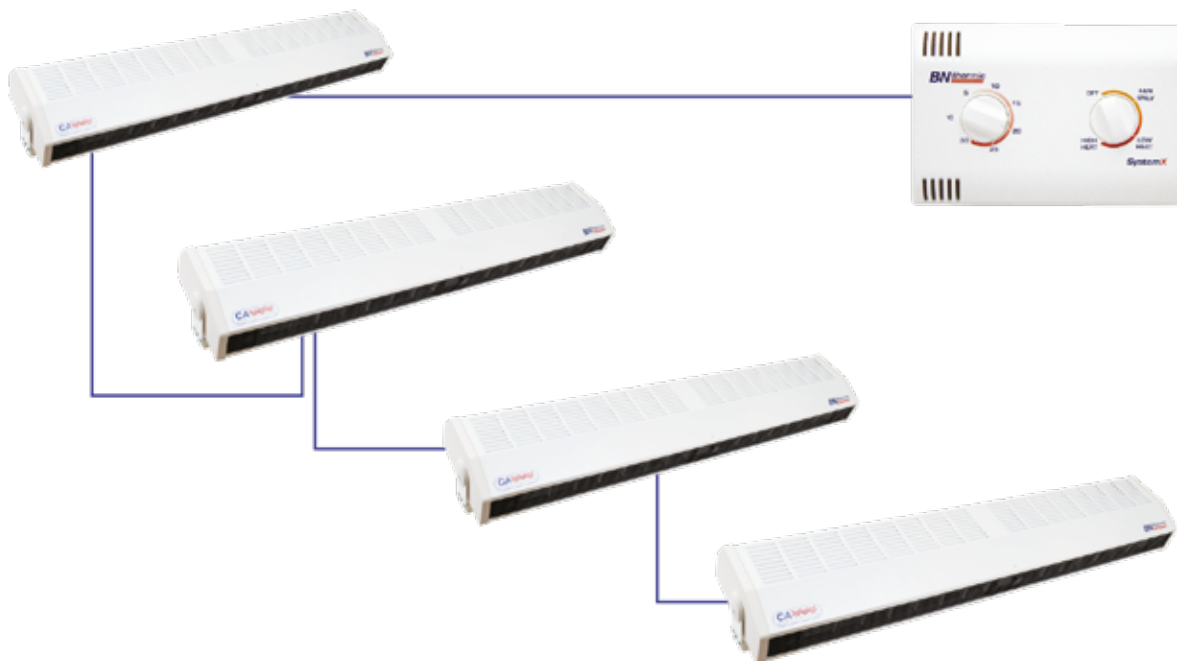

## Key Features

- Control up to 12 air curtains from a single point
- Bracket for wall or ceiling mounting
- M8 threaded holes for drop rod suspension
- All control connections by Cat5 cable for super quick error-free installation
- Controllers do not require their own 230V supply
- BMS compatible using CX-BMS module
- Can be controlled in a group with any other style of SystemX heater











**ENERGY SAVING TIP**  
Installing a CX1, 2 or 3 controller gives you a low heat option which reduces your electricity consumption (ideal for warmer months)

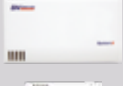

## SystemX Commercial Air Curtains

Model	kW	Length (mm)	List Price
XAS-30	3.0	635	£684.00
XAS-45	4.5	635	£697.00
XAD-60	6.0	1105	£988.00
XAD-90	9.0	1105	£1,038.00
XAT-90	9.0	1620	£1216.00
XAT-135	13.5	1620	£1399.00
XAH-180	18.0	2085	£1938.00

## SystemX Control Components

	Description	Model	Details	List Price
	Controller with thermostat On/off/low/high/fan only settings	CX1	Page 119	£144.00
	Controller with tamper resistant thermostat On/off/low/high/fan only settings	CX2	Page 119	£147.00
	Controller - manual On/off/low/high/fan only settings	CX3	Page 119	£146.00
	Controller with digital programmable thermostat	CX6	Page 119	£253.00
	BMS module for use with volt-free signal	CX-BMS	Page 119	£137.00
	Optional remote sensor for use with CX1, CX2 or CX6 controllers	CXS	Page 119	£42.00
	Cat5 cable terminated 5m	DX05	-	£10.00
	Cat5 cable terminated 10m	DX10	-	£15.00
	Cat5 cable terminated 20m	DX20	-	£23.00
	Cat5 cable joiner	JX1	-	£5.50

## Technical

Model	kW		Volts	Airflow (m³/h)	dB* @2m	Recommended Mounting Height(m)		Dimensions (mm)			Weight (kg)
	High	Low				Min	Max	W	D	H	
XAS	3.0	2.0	230	345	60	2.5	3.5	635	108	225	8.5
XAS	4.5	2.25	230	345	60	2.5	3.5	635	108	225	8.5
XAD	6.0	4.0	230	690	62	2.5	3.5	1105	108	225	13.5
XAD	9.0	4.5	230	690	62	2.5	3.5	1105	108	225	13.5
XAT	9.0	6.0	230 or 400/3N	1035	62	2.5	3.5	1620	108	225	19
XAT	13.5	6.75	400/3N	1035	62	2.5	3.5	1620	108	225	19
XAH	18.0	12.0	400/3N	1440	66	2.5	3.5	2085	108	225	23

\*Noise levels are factory tested not laboratory tested



### M3 Service Station

**Location:** Hampshire

**Installed:** 1 x 9kW Commercial Air Curtain



## Bedford Timber Supplies

**Location:** Bedford

**Installed:** 1 x 13.5kW Commercial Air Curtain

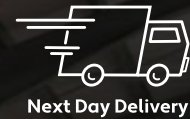

# INDUSTRIAL FAN HEATERS

## What is an Industrial Fan Heater ?

A rugged and reliable UK manufactured fan heater backed with a 5 year warranty. These units are designed to space heat large industrial premises such as warehouses, workshops and factories.



## Key Features

- FIVE YEAR WARRANTY
- Robust all-steel construction
- Bracket for wall or ceiling mounting and hooks for vertical suspension (The OUH3-40 can only be hung from 10mm drop rods)
- Built-in adjustable thermostat plus overtemperature and heat purge devices
- Fitted with fused control circuit and contactor
- Optional switch provides on/off/fan only settings
- Remote-mounted programmable thermostats available
- Up to 16 heaters can be connected together and controlled from a single controller









### ENERGY SAVING TIP

Installing a destratification unit can reduce your heating bill by up to 30% (see page 56)

## OUH Industrial Fan Heaters

Model	kW	List Price
OUH3-03	3.0	£1,186.00
OUH3-06	6.0	£1,239.00
OUH3-09	9.0	£1,326.00
OUH3-15	15	£1,834.00
OUH3-20	20	£1,968.00
OUH3-25	25	£1,999.00
OUH3-40 <b>NEW</b>	40	£2,998.00

## Control and Accessories

	Description	Model	Details	List Price
	Switch (On/off/fan only)	OUH3-S	Page 123	£79.00
	Programmable wall-mounted thermostat + Fan Only override for OUH3 industrial fan heaters	OUH3-DT	Page 118	£154.00
	Programmable / WiFi wall-mounted thermostat + fan only override for OUH3 industrial fan heaters	OUH3-WIFI	Page 118	£211.00
	Optional remote air sensor for OUH3-DT or OUH3-WIFI	CXS	Page 119	£42.00
	Mechanical frost thermostat. Overrides other thermostats and OUH3-S switch	FST-RS	Page 111	£138.00
	Industrial tamperproof room thermostat	RST-RS	Page 110	£143.00
	Suspension kit for OUH3 heaters (four hooks and locknuts) (Do not use with the OUH3-40)	OUH3-HK	-	£12.00

## Technical

Model	Volts	Airflow (m3/h)	dB*@2m	W	D	H	Weight (kg)
OUH3-03	230	1100	60	435	405	320	18
OUH3-06	230	1100	60	435	405	320	18
OUH3-09	230 or 400/3N	1100	60	435	405	320	18.5
OUH3-15	400/3N	3150	62	565	485	445	37
OUH3-20	400/3N	3150	62	565	485	445	37.5
OUH3-25	400/3N	3150	62	565	485	445	38.5
OUH3-40	400/3N	5600	64	642	765	582	56

\*Noise levels are factory tested not laboratory tested

Where roof height exceeds 4m we recommend using our DSU destratification units (see pages 56-57).



### Maranello Ferrari

**Location:** Egham, Surrey

**Installed:** 2 x 20kW Industrial Fan Heaters



## Quaife Engineering Ltd

**Location:** Sevenoaks, Kent

**Installed:** 2 x 25kW Industrial Fan Heaters

3 x 10kW Industrial Fan Heaters



Next Day Delivery



Purchase from  
Electrical Wholesaler

# DESTRATIFICATION UNITS

## What is a Destratification Unit ?

A large fan you suspend from ceilings in industrial buildings with ceiling heights that exceed 4m. A destratification unit pushes down warm air which has risen and accumulated at high level which can save up to 30% off your heating bill. These units are often combined with BN Thermic OUH3 industrial fan heaters.



## Key Features

- Built-in thermostat automatically energises fan
- Robust all-steel construction
- Suspension kit provided (500mm chains and associated hooks)
- Optional DSU-2R fan speed regulator recommended to limit noise/draught (only suitable for DSU3-40 and DSU3-50 models)



### ENERGY SAVING TIP

Save up to 30% off your heating bill by installing a destratification unit



## DSU Destratification Units

Model	Description	Details	List Price
DSU3-40	Destratification unit (roof 4-7m)	-	£897.00
DSU3-45	Destratification unit (roof 7-10m)	-	£949.00
DSU3-50 <b>NEW</b>	Destratification unit (roof 10-15m)	-	£1,130.00
DSU-2R <b>NEW</b>	Fan Speed Regulator (each unit requires its own regulator) Not suitable for DSU3-45	Page 127	£170.00

## Technical

Model	Volts	Airflow (m <sup>3</sup> /h)	Fan Motor (W)	Roof Height (m)	Area Covered (m)	dB* @ 5m	Dimensions (mm)			Weight (kg)
							H	W	D	
DSU3-40	230	3800	180	4-7	18 x 18	62	300	600	600	18
DSU3-45	230	5600	240	7-10	20 x 20	64	300	600	600	20
DSU3-50	230	7650	380	10-15	25 x 25	65	300	600	600	22

\*Noise levels are factory tested not laboratory tested

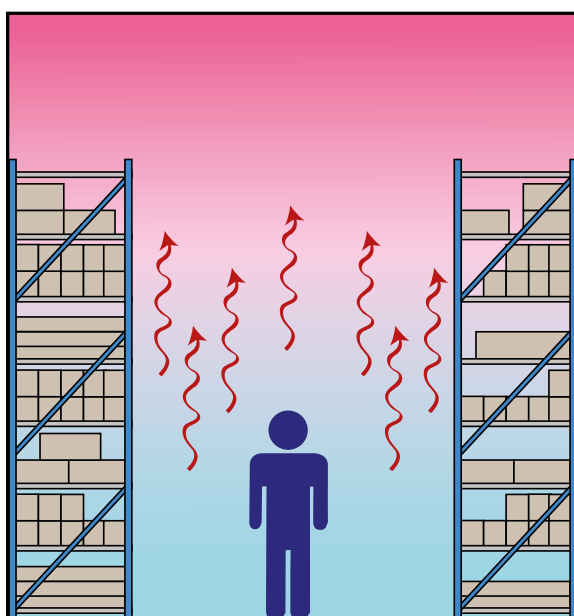

**Without DSU3**

Warm air accumulates at high level

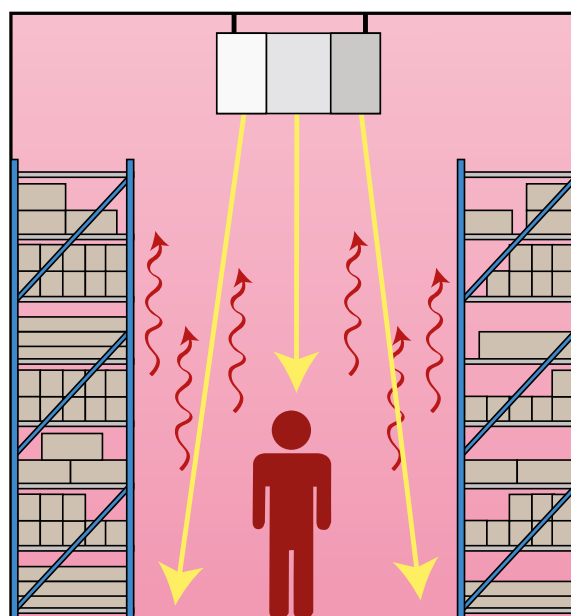

**With DSU3**

Warm air is recycled reducing heating costs by up to 30%



### Allon White Sports Cars

**Location:** Cranfield, Bedfordshire

**Installed:** 1 x destratification unit; 2 x 20kW industrial fan heater



## Industrial Unit

**Location:** Plymouth, Devon

**Installed:** 1 x destratification unit; 2 x 25kW industrial fan heaters;  
1 x DSU-2R fan speed regulator



Next Day Delivery



Purchase from  
Electrical Wholesaler

## PEW HEATERS

### What is a Pew Heater ?

A discreet and unobtrusive heater that lives under church pews and directly heats pew occupants. Pew heaters have become a staple product for churches looking for a low carbon electric heating system.



### Key Features

- Mounted directly below pew's seat
- Dark brown paint finish reduces visual impact
- Silent draught-free operation
- Fixed directly to a pew's backboard or using optional brackets
- Robust steel construction
- 20mm cable entries at both ends for electrical connection
- External guard not required



#### ENERGY SAVING TIP

Installing an on/off switch on each pew enables you to only heat pews when they are occupied

## Heaters

Model	Length (mm)	kW	List Price
PH30	525	0.3	£180.00
PH45	702	0.45	£204.00
PH65	948	0.65	£223.00

## Technical

Model	kW	Volts	Dimensions (mm)			Weight (kg)
			L	D	H	
PH30	0.3	230	525	58	168	2.4
PH45	0.45	230	702	58	168	3.1
PH65	0.65	230	948	58	168	4.1

## Optional Brackets

Model	Description	List Price
PHB	Suspension brackets (pair) assembled height 290mm	£40.00
PHF	Floor brackets (pair) assembled height 204mm	£34.00

## Selection

Space Between Seat Supports (mm)		Recommended Heater
Minimum	Maximum	
600	750	PH30
750	1000	PH45
1000	1500	PH65
1500+		Multiple heaters

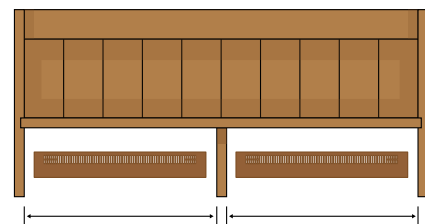



## St James' Church

**Location:** Egerton, Kent

**Installed:** 45 x 300W Pew Heaters



## Holy Trinity Church

**Location:** Coalbrookdale, Telford

**Installed:** 54 x 450W Pew Heaters



Next Day Delivery



Purchase from  
Electrical Wholesaler

# INDUSTRIAL FINNED TUBULAR HEATERS

## What is an Industrial Tubular Heater ?

A rugged and reliable IP66 rated stainless steel finned tubular heater. This heater is designed to live and operate in damp/corrosive environments such as industrial kiosks, water treatment facilities, lift shafts and pumping stations. It's a real 'fit and forget' product and can be used to space heat or provide frost protection.



## Key Features

- Welded stainless steel construction
- Waterproof glass fibre terminal box IP66 rated
- Brackets for wall or floor mounting and M20 cable gland supplied as standard
- Available with or without built-in thermostat
- Optional zinc plated wire guards available



### ENERGY SAVING TIP

Select a SWD-A model with a built in energy saving thermostat



## SWD Industrial Finned Tubular Heaters

Model	kW	Volts	Built-in Thermostat	List Price
SWD-A-500	0.5	230	Yes	£629.00
SWD-A-1000	1.0	230	Yes	£718.00
SWD-A-1500	1.5	230	Yes	£842.00
SWD-A-2000	2.0	230	Yes	£915.00
SWD-A-3000	3.0	230	Yes	£1,220.00
SWD-U-500	0.5	230	No	£453.00
SWD-U-1000	1.0	230 or 400/3	No	£543.00
SWD-U-1500	1.5	230 or 400/3	No	£655.00
SWD-U-2000	2.0	230 or 400/3	No	£748.00
SWD-U-3000	3.0	230 or 400/3	No	£1,037.00
SWD-U-4000	4.0	230 or 400/3	No	£1,435.00
SWD-U-500-1	0.5	110	No	£508.00
SWD-U-1000-1	1.0	110	No	£666.00
SWD-U-1500-1	1.5	110	No	£734.00

## Technical

kW	Dimensions (mm)			Weight (kg)	Optional Guard
	L	W	H		
0.5	440	130	170	3.0	SWG-1
1.0	640	130	170	4.8	SWG-2
1.5	840	130	170	6.2	SWG-3
2.0	1040	130	170	7.7	SWG-3
3.0	1440	130	170	10.9	SWG-4
4.0	1840	130	170	13.7	SWG-5

## Optional Guards

Model	Dimensions (mm)			Weight (kg)	List Price
	L	W	H		
SWG-1	450	240	240	1.0	£100.00
SWG-2	650	240	240	1.5	£126.00
SWG-3	1075	240	240	2.0	£148.00
SWG-4	1600	240	240	3.5	£238.00
SWG-5	1900	240	240	4.0	£247.00



## Control Room

**Location:** Various UK Locations

**Installed:** 1 x 500W Industrial Finned Tubular Heater with Thermostat



## Industrial Kiosk

**Location:** Various Worldwide Locations

**Installed:** 1 x 1kW Industrial Finned Tubular Heater with Thermostat



Next Day Delivery



Purchase from  
Electrical Wholesaler

# EXPLOSION-PROOF TUBULAR HEATERS

## What is an Explosion Proof Tubular Heater ?

An ATEX rated finned tubular heater that provides space heating or frost protection when hazardous dust/gas may be present. These are most commonly installed in petrochemical installations, spray booths and storage areas.

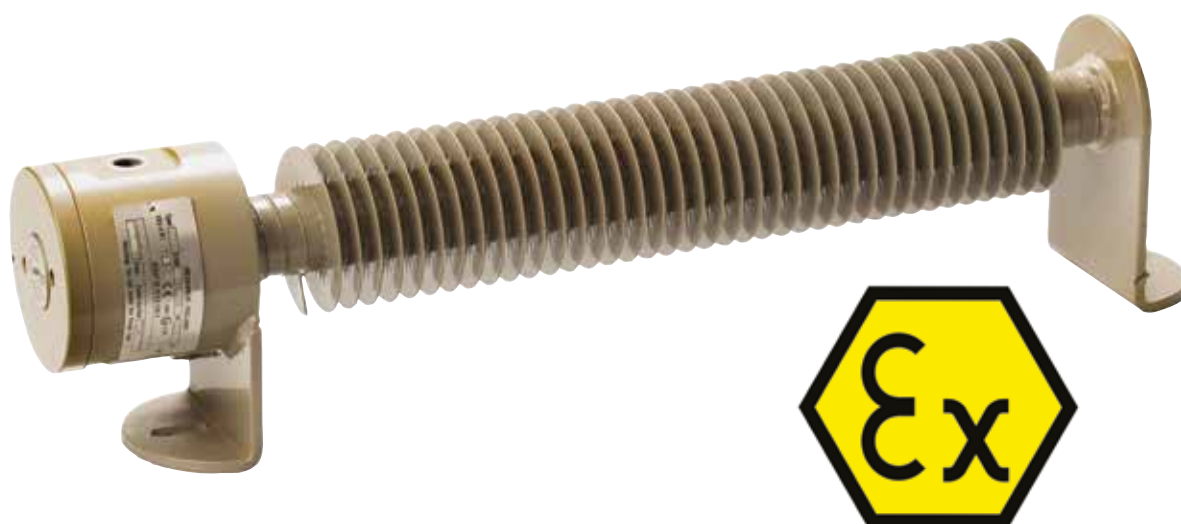

## Key Features

- ATEX certified
- Equipment protection level Gb (gas) and Db (dust)
- Zones 1, 2, 21, 22 Groups IIC (gas), IIIC (dust)
- Temperature Class T3 (maximum ambient 40°C)
- IP66 rating
- Steel construction with grey epoxy finish
- Sturdy mounting feet for wall or floor mounting
- Optional zinc plated safety guards (open ended)



### ENERGY SAVING TIP

If suitable for your application, control with an energy saving TXST-01 thermostat

## TX Explosion Proof Tubular Heaters

Model	kW	List Price
TXT3-05	0.5	£2,002.00
TXT3-10	1.0	£2,077.00
TXT3-15	1.5	£2,286.00

## Thermostats

Model	Description	Details	List Price
TXST-01	ATEX thermostat (hazardous gas only)	Page 117	£1,043.00

## Technical

Model	kW	Voltage	Dimensions (mm)			Weight (kg)	Optional Guard
			L	H	W		
TXT3-05	0.5	230	850	157	100	11.5	TXG-01
TXT3-10	1.0	230	1450	157	100	16.0	TXG-02
TXT3-15	1.5	230	2050	157	100	19.5	TXG-01 + TXG-02

## Optional Guards

Model	Dimensions (mm)			Weight (kg)	List Price
	L	W	H		
TXG-01	739	190	153	1.0	£75.00
TXG-02	1348	190	153	2.0	£92.00



# 'ALL BLACK' RADIANT HEATERS

## What is an 'All Black' Terrace Heater ?

A discreet longwave radiant heater which provides radiant comfort heat with zero light output. These heaters are ideally suited to heating enclosed or semi enclosed indoor areas such as food courts, conservatories and orangeries.



## Key Features

- Sophisticated 'all black' design
- IP44 rated
- Wall bracket with 'up and down' angle adjustment
- 2m power lead



### ENERGY SAVING TIP

Control with a TS-8 run down timer to avoid heating an unoccupied area

## ETH Radiant Heaters

Model	kW	List Price
ETH-10	1.0	£472.00
ETH-15	1.5	£554.00

## Technical

Model	kW	Volts	Dimensions (mm)			Weight (kg)
			H	W	D	
ETH-10	1.0	230	140	1080	45	4.0
ETH-15	1.5	230	140	1580	45	6.0



### The Cabin Bar

**Location:** Waterloo Train Station, London

**Installed:** 23 x 1.5kW All Black Radiant Heaters





## The Village

**Location:** Solihull, West Midlands

**Installed:** 8 x 1.5kW All Black Radiant Heaters



# PATIO HEATERS

## What is a Patio Heater ?

A shortwave radiant heater which creates inviting outdoor environments for customers, family and friends. They are commonly installed in pubs, cafes, restaurants and domestic gardens. Our 'magic lamp' heaters provide the same 'punchy' shortwave heat as our standard lamps but without a red beam.



## Key Features

- IP55 rated for outdoor use
- Replaceable halogen lamp with 7000 hours average operating life
- Wall bracket with 'up and down' angle adjustment
- Can be suspended
- 3m power lead
- Magic Lamp option for reduced light output and zero-glare



**ENERGY SAVING TIP**  
Control with a TS-7 run down timer to avoid heating an unoccupied area





## Standard Heaters

Model	kW	Finish	Lamp Glow	List Price
HWP2-B	1.5	Black	Gold	£218.00
HWP2-W	1.5	White	Gold	£218.00
HWP2-S	1.5	Silver	Gold	£218.00
HWP2-2B	2.0	Black	Red	£260.00
HWP2-2W	2.0	White	Red	£260.00
HWP2-3B	3.0	Black	Red	£368.00
HWP2-3W	3.0	White	Red	£368.00
HWP2-45B	4.5	Black	Red	£520.00

## Magic Lamp Heaters

Model	kW	Finish	Lamp Glow	List Price
HWP2-BM	1.5	Black	Magic Lamp (zero glare)	£310.00
HWP2-WM	1.5	White	Magic Lamp (zero glare)	£310.00
HWP2-SM	1.5	Silver	Magic Lamp (zero glare)	£310.00
HWP2-2BM	2.0	Black	Magic Lamp (zero glare)	£315.00
HWP2-2WM	2.0	White	Magic Lamp (zero glare)	£315.00
HWP2-3BM	3.0	Black	Magic Lamp (zero glare)	£555.00
HWP2-3WM	3.0	White	Magic Lamp (zero glare)	£555.00
HWP2-45BM	4.5	Black	Magic Lamp (zero glare)	£750.00

## Accessories

Model	Description	Details	List Price
 VR-2	Dimmer (3kW max)	Page 126	£184.00
 TS-7	Push button timer (Light grey finish)	Page 120	£205.00
 TS-7B	Push button timer (Black finish)	Page 120	£205.00
 WH-402	Movement sensor (3kW max)	Page 126	£130.00

## Technical

kW	Volts	Dimensions (mm)			Weight (kg)
		H	W	D	
1.5	230	120	480	140	1.7
2.0	230	120	480	140	1.7
3.0	230	120	960	140	3.2
4.5	230 or 400/3N	120	1440	140	4.9

## Area Covered (wall mounted)

kW	H (m)	X (m)	Y (m)	Z (m)	m <sup>2</sup>
1.5 or 2.0	2.0	2.3	2.4	4.0	7.6
1.5 or 2.0	2.5	3.0	3.0	5.2	12.3
3.0	2.0	3.4	2.4	4.5	9.5
3.0	2.5	4.2	3.0	5.8	15.0
4.5	2.0	4.3	2.4	5.0	11.2
4.5	2.5	4.8	3.0	6.4	16.8

For outdoor applications we recommend  
300W/m<sup>2</sup> minimum

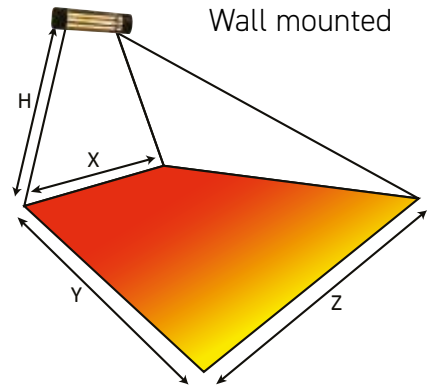

## Area Covered (overhead mounted)

kW	H (m)	X (m)	Y (m)	m <sup>2</sup>
1.5 or 2.0	2.0	3.6	2.5	9.0
1.5 or 2.0	2.5	4.8	3.5	16.8
3.0	2.0	4.3	2.5	10.7
3.0	2.5	5.2	3.5	18.2
4.5	2.0	4.8	2.5	12.0
4.5	2.5	5.6	3.5	19.6

For outdoor applications we recommend  
300W/m<sup>2</sup> minimum

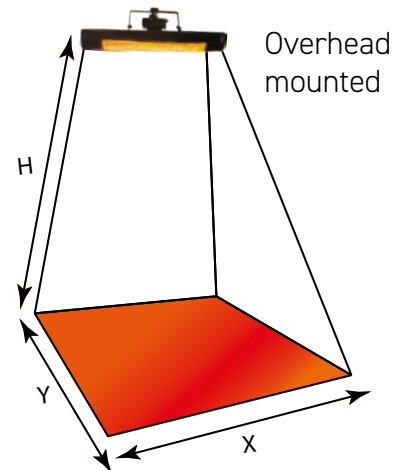

## Replacement Lamps

Heater	Lamp Model	kW	Qty Fitted	List Price
HWP2 Standard	RL15CW	1.5	1	£64.00
HWP2 Magic Lamp	RL15MW	1.5	1	£151.00
HWP2-2 Standard	RL20GW	2.0	1	£86.00
HWP2-2 Magic Lamp	RL20MW	2.0	1	£155.00
HWP2-3 Standard	RL15GW/3	1.5	2	£81.00
HWP2-3 Magic Lamp	RL15MW/3	1.5	2	£151.00
HWP2-45 Standard	RL15GW/4	1.5	2 (outside lamps)	£81.00
	RL15GW	1.5	1 (centre lamp)	£81.00
HWP2-45 Magic Lamp	RL15MW/4	1.5	2 (outside lamps)	£151.00
	RL15MW	1.5	1 (centre lamp)	£151.00



## London Hippodrome Casino

**Location:** London

**Installed:** 12 x 2kW Patio Heaters



## Top Golf

**Location:** Watford, London

**Installed:** 86 x 2kW Patio Heaters

## Brewhouse & Kitchen

**Location:** Cardiff, Wales

**Installed:** 4 x 2kW Patio Heaters



## The Star

**Location:** Hackney, London

**Installed:** 7 x 1.5kW Patio Heaters



# INFRARED QUARTZ HALOGEN HEATERS

## What is an Infrared Quartz Halogen Heater?

A shortwave radiant heater which heats people directly not the surrounding air. As they are instantly effective, these heaters are ideal for spot heating workstations in warehouses and also heating intermittently used buildings like churches, village halls and schools.



## Key features

- Replaceable halogen lamp with 7000 hours average operating life
- Wall bracket with 'up and down' and 'side to side' angle adjustment
- Can be suspended (optional suspension kit available)
- 1m power lead (2-core and earth)
- Magic Lamp option for reduced light output and zero-glare (M suffix)



**ENERGY SAVING TIP**  
Control with a TS-7 run down timer to avoid heating an unoccupied area.



## Single Lamp Heaters

Model	kW	Finish	Lamp Glow	List Price
HN3-15	1.5	Ivory	Red	£260.00
HN3-15B	1.5	Black	Red	£260.00
HN3-15M	1.5	Ivory	Magic Lamp (zero glare)	£320.00
HN3-15BM	1.5	Black	Magic Lamp (zero glare)	£320.00
HN3-20	2.0	Ivory	Red	£271.00
HN3-20B	2.0	Black	Red	£271.00
HN3-20M	2.0	Ivory	Magic Lamp (zero glare)	£325.00
HN3-20BM	2.0	Black	Magic Lamp (zero glare)	£325.00

## Twin Lamp Heaters

Model	kW	Orientation	Finish	Lamp Glow	List Price
HN3-30	3.0	Vertical	Ivory	Red	£420.00
HN3-30B	3.0	Vertical	Black	Red	£420.00
HN3-30M	3.0	Vertical	Ivory	Magic Lamp (zero glare)	£510.00
HN3-30BM	3.0	Vertical	Black	Magic Lamp (zero glare)	£510.00
HN3-30L	3.0	Linear	Ivory	Red	£420.00
HN3-30LB	3.0	Linear	Black	Red	£420.00
HN3-30LM	3.0	Linear	Ivory	Magic Lamp (zero glare)	£510.00
HN3-30LBM	3.0	Linear	Black	Magic Lamp (zero glare)	£510.00

## Three Lamp Heaters









Model	kW	Finish	Lamp Glow	List Price
HN3-45	4.5	Ivory	Red	£620.00
HN3-45B	4.5	Black	Red	£620.00
HN3-45M	4.5	Ivory	Magic Lamp (zero glare)	£748.00
HN3-45BM	4.5	Black	Magic Lamp (zero glare)	£748.00
HN3-60	6.0	Ivory	Red	£698.00
HN3-60B	6.0	Black	Red	£698.00
HN3-60M	6.0	Ivory	Magic Lamp (zero glare)	£800.00
HN3-60BM	6.0	Black	Magic Lamp (zero glare)	£800.00

## Technical

Lamps	Volts	Dimensions (mm)			Weight (kg)
		H	W	D	
1	230	218	375	100	2.6
2 (vertical)	230	376	375	100	4.6
2 (linear)	230	218	788	100	4.6
3	230/400	536	375	100	6.3

continued

## Accessories

Model	Description	Details	List Price
 HSK	Suspension kit (four hooks and locknuts)	--	£10.00
 CS-4	Switch for 1.5kW, 2kW, 3kW heaters: on/off	Page 123	£60.00
 CS-2	Switch for 3kW vertical heaters: ½ heat/full heat	Page 122	£78.00
 CS-3	Switch for 4.5kW, 6kW heaters: ⅓ heat/ ⅔ heat/full heat	Page 122	£105.00
 VR-2	Dimmer (3kW max)	Page 126	£184.00
 TS-7	Push button timer (Light grey finish) (6kW max)	Page 120	£205.00
 TS-7B	Push button timer (Black finish) (6kW max)	Page 120	£205.00
 WH-402	Movement sensor (3kW max)	Page 126	£130.00

For multi-heater installations we recommend our HC control box (see page 88-91)

## Replacement Lamps

Model	kW	Glow	List Price
RL15GF	1.5	Red	£78.00
RL15MF	1.5	Magic Lamp (zero glare)	£140.00
RL20GF	2.0	Red	£80.00
RL20MF	2.0	Magic Lamp (zero glare)	£140.00

## Required W/m<sup>2</sup>

	Heavy Work (W/m <sup>2</sup> )	Light Work (W/m <sup>2</sup> )	Spot Heating (W/m <sup>2</sup> )
Highly Insulated	150	200	250
Insulated	175	225	250
Uninsulated	200	250	275
Light cladding	250	300	300
Badly insulated/damp	300	300	300

## Area Covered (wall mounted)

kW	H (m)	X (m)	Y (m)	Z (m)	m <sup>2</sup>
1.5 or 2.0	2.5	3.2	2.6	6.0	11.9
1.5 or 2.0	3.0	3.4	3.6	6.7	18.2
3.0 Vertical	3.0	3.7	3.6	7.0	19.2
3.0 Vertical	3.5	4.0	4.2	7.9	25.0
3.0 Linear	2.5	3.6	2.6	6.4	13.0
3.0 Linear	3.0	3.8	2.6	7.1	19.6
4.5 or 6.0	3.5	4.0	4.2	8.1	25.4
4.5 or 6.0	4.0	4.3	4.5	8.4	28.6

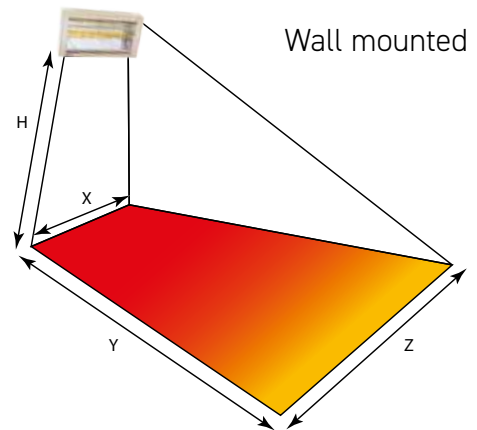

## Area Covered (overhead mounted)

kW	H (m)	X (m)	Y (m)	m <sup>2</sup>
1.5 or 2.0	3.0	3.0	2.0	6.0
1.5 or 2.0	3.5	3.3	2.3	7.6
3.0 Vertical	3.5	3.3	2.6	8.6
3.0 Vertical	4.0	5.0	3.1	15.5
3.0 Linear	3.5	3.8	2.6	9.9
3.0 Linear	4.0	5.5	2.8	15.4
4.5 or 6.0	4.0	5.0	3.4	17.0
4.5 or 6.0	5.0	5.3	3.7	19.6

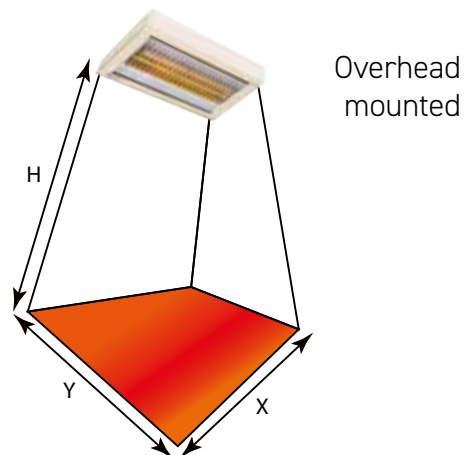



### Play Centre

**Location:** Wirral, Merseyside

**Installed:** 8 x 4.5 Quartz Halogen Heaters  
6 x 3kW Quartz Halogen Heaters



### St Peters Church

**Location:** Pavenham, Bedfordshire

**Installed:** 12 x 3kW Quartz Halogen Heaters  
with Magic Lamps

## Snickers Distribution Centre

**Location:** South Coast

**Installed:** 2 x 1.5kW Quartz Halogen Heaters



## Distribution Centre

**Location:** Market Harborough, Leicestershire

**Installed:** 53 x 1.5kW Quartz Halogen Heaters with Magic Lamps



### Green Street Baptist Church

**Location:** Orpington, Kent

**Installed:** 8 x 3kW Quartz Halogen Heaters with Magic Lamps

10 x 2kW Quartz Halogen Heaters with Magic Lamps



## Pharmacy Warehouse

**Location:** Croydon, South London

**Installed:** 10 x 4.5kW Quartz Halogen Heaters with Magic Lamps  
3 x HC3 Multi Heater Control Boxes

# INFRARED QUARTZ HALOGEN HEATER CONTROL BOX

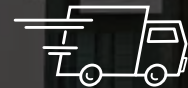

Next Day Delivery



Purchase from  
Electrical Wholesaler

## What is an Infrared Quartz Halogen Heater Control Box?

A control box that speeds up and simplifies multi quartz halogen heater installs. A typical HC control box installation will require less cable, less MCB's or RCB's and less junction boxes. It is also quicker to install as each circuit is individually fused. These control boxes also allow end users to adjust heat intensity on multiple heaters from one simple controller.







## Control Panel Features

- For use with HN3 halogen heaters (see pages 80-87)
- Up to 6 heaters controlled from a single control box
- For large installations up to 10 control boxes can be connected using data cable
- Frost thermostat can be connected to control box overriding all other controls
- Soft start switching prolongs lamp life

## Controller Features

- Connected to control panel using data cable
- Manual selection 3kW heaters - off / half heat / full heat
- Manual selection 4.5kW or 6kW heaters - off / 1/3 heat / 2/3 heat / full heat
- Built-in run-down timer (if required) programmable between 5 minutes and two hours activated by remote-mounted push button (HC-B)
- IP66 rough service controllers available **NEW**

## Control Boxes

Model	Description	List Price Each
HC2	Control box for up to six 3kW heaters*	£760.00
HC3	Control box for up to four 4.5 or 6kW heaters	£760.00
HC-C1	Controller (see page 124)	£146.00
 HC-CRS	IP66 rough service controller (see page 124)	£153.00
 HC-TMRS	IP66 rough service controller with run down timer (see page 125)	£181.00

\*Not suitable for linear models

## Ancillary System Components

Model	Description	Details	List Price
HC-B	Push Button to activate HC-C1 run-down timer	Page 124	£59.00
FST-RS	Optional frost thermostat	Page 111	£138.00
DX05	Cat5 cable terminated 5m	-	£10.00
DX10	Cat5 cable terminated 10m	-	£15.00
DX20	Cat5 cable terminated 20m	-	£23.00
JX1	Cat5 Cable Joiner	-	£5.50

Cat5 cable used to connect controller to a control box and to interconnect control boxes

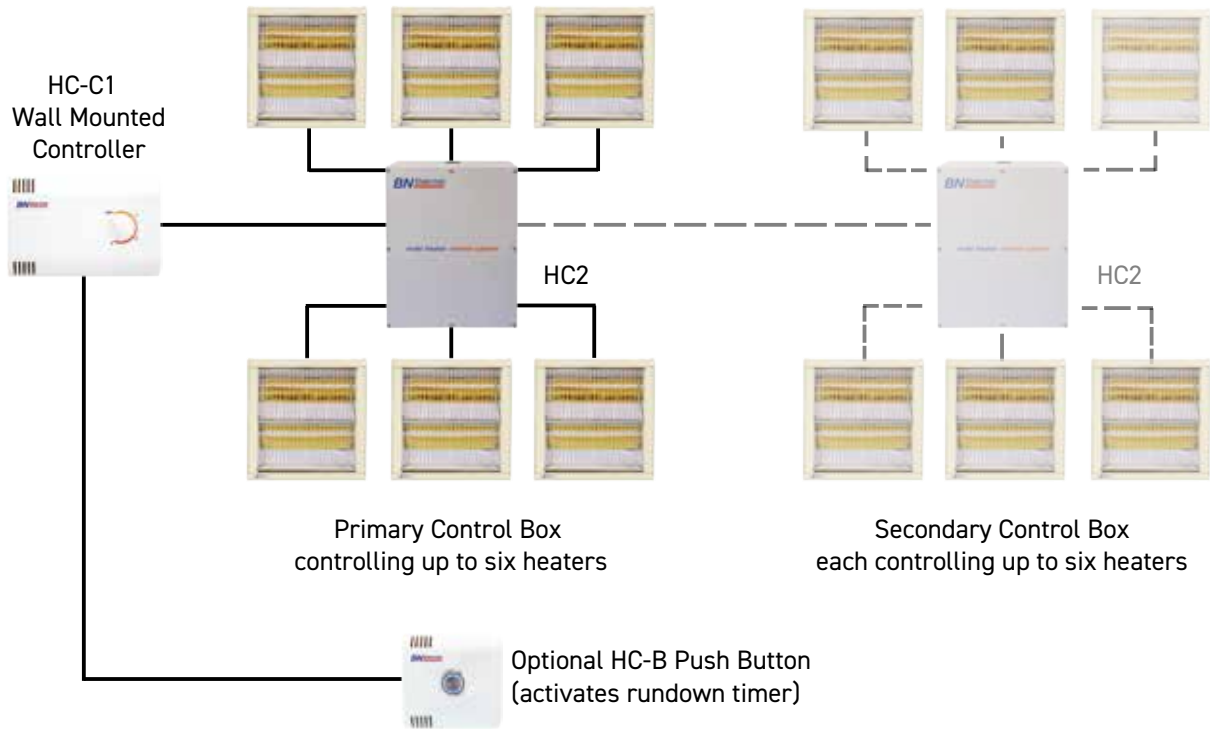

## Controlling HN3-30 (3kW) Heaters each with 2 Lamps

Each HC2 control box will control up to six heaters. The HC-C1 controller allows the heaters' lamps to be switched individually meaning that outputs of 1.5kW or 3kW can be selected.

400V 3ph & N supply required.

For larger installations up to 10 control boxes can be connected in a control daisy-chain with each controlling up to six heaters.

Note: this system cannot be used with linear heaters.

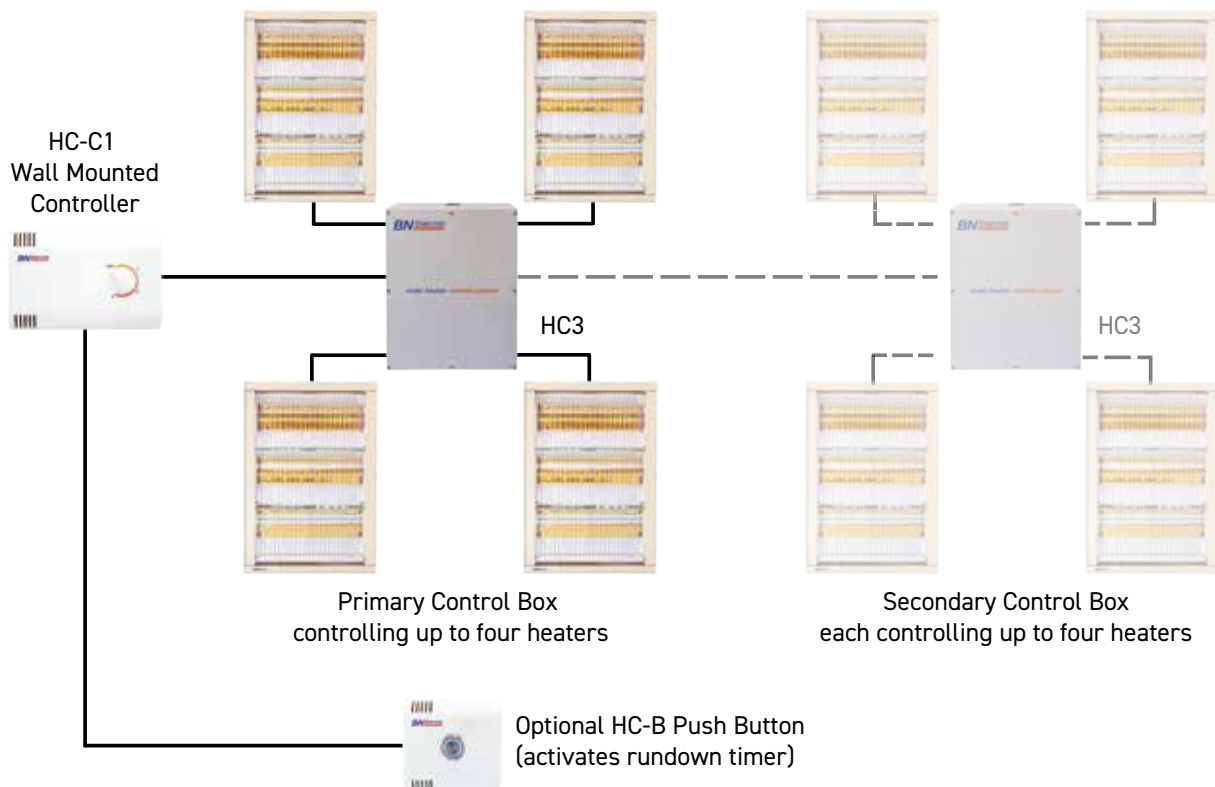

## Controlling HN3-45 (4.5kW) Heaters or HN3-60 (6kW) Heaters each with 3 Lamps

Each HC3 control box will control up to four heaters. The HC-C1 controller allows the heaters' lamps to be switched individually meaning that outputs of  $\frac{1}{3}$ ,  $\frac{2}{3}$  or full power can be selected.

400V 3ph & N supply required

For larger installations up to 10 control boxes can be connected in a control daisy-chain with each controlling up to four heaters.

# CERAMIC HEATERS

## What is a Ceramic Heater ?

A medium wave radiant heater that heats people directly with zero light output. Ideally suited for intermittently used applications where visible light output from a heater is not acceptable.



## Key Features

- Long life 'no glow' ceramic heat emitters
- Wall bracket with 'up and down' and 'side to side' angle adjustment
- Can be suspended (optional suspension kit available)
- 1m power lead (2-core and earth)



**ENERGY SAVING TIP**  
Control with a TS-8 run down timer to avoid heating an unoccupied area





## Heaters

Model	kW	Finish	List Price
CH2-15	1.5	Ivory	£320.00
CH2-15B	1.5	Black	£320.00
CH2-30	3.0	Ivory	£488.00
CH2-30B	3.0	Black	£488.00
CH2-30L	3.0	Ivory	£488.00
CH2-30LB	3.0	Black	£488.00

## Technical

Model	kW	Volts	Dimensions (mm)			Weight (kg)
			H	W	D	
CH2-15	1.5	230	218	375	100	3.2
CH2-30	3.0	230	376	375	100	5.7
CH2-30L	3.0	230	218	788	100	5.7

## Accessories

Model	Description	Details	List Price
 HSK	Suspension kit (four hooks and locknuts)	--	£10.00
 VR-2	Dimmer (3kW max)	Page 126	£184.00
 TS-8	Push button timer (7.2kW max) Light grey finish	Page 121	£207.00
 TS-8B	Push button timer (7.2kW max) Black finish	Page 121	£207.00
 WH-402	Movement sensor (3kW max)	Page 123	£130.00



### Tunstall Village Hall

**Location:** Sittingbourne, Kent

**Installed:** 6 x 3kW Ceramic Heaters



## Train Stations

**Location:** Multiple TFL Locations  
**Installed:** 1.5kW and 3kW Ceramic Heaters



Next Day Delivery



Purchase from  
Electrical Wholesaler

# RADIANT CEILING PANELS

## What is a Radiant Ceiling Panel ?

A discrete energy efficient heater used to space heat commercial premises such as offices, classrooms and care homes. Radiant panels free up valuable wall space and can be installed easily into a ceiling grid or surface mounted.

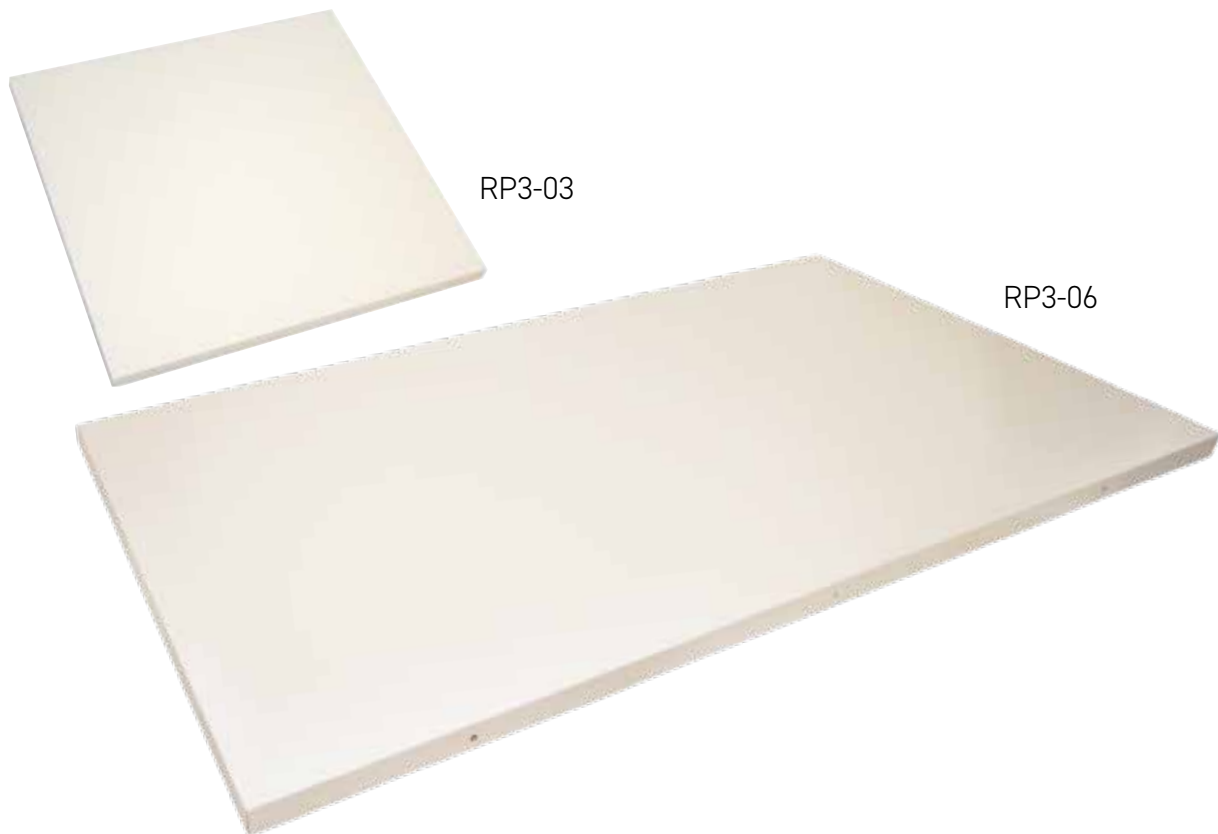

## Key Features

- Radiant heat without light output
- Quick and easy installation into a standard (24mm) suspended ceiling grid
- Bracket provided for easy mounting onto a conventional ceiling
- Attractive white easy-clean finish (RAL9010)
- IP44 rated



### ENERGY SAVING TIP

Radiant panel's radiant effect makes you feel warmer than the actual ambient air temp. This means you can set your thermostat 3-4°C lower.











## Heaters

Model	kW	List Price
RP3-03	0.3	£260.00
RP3-06	0.6	£375.00

## Technical

Model	kW	Volts	Dimensions (mm)			Recommended Mounting Height (m)		Weight (kg)
			H	W	D	Min	Max	
RP3-03	0.3	230	25	592	592	2.4	4.0	5.9
RP3-06	0.6	230	25	1192	592	2.4	4.0	11.3

## Accessories

Model	Description	Details	List Price
 RD16	Electronic programmable thermostat 16A (recessed)*	Page 112	£65.00
 RT16	Programmable thermostat 16A*	Page 112	£144.00
 RT26	Programmable thermostat 26A*	Page 113	£177.00
 WD16	Wi-Fi thermostat 16A (recessed – free app)*	Page 113	£130.00
 WT16	Wi-Fi thermostat 16A (free app)*	Page 114	£222.00
 WT26	Wi-Fi thermostat 26A (free app)*	Page 114	£269.00
 CXS	Optional remote-mounted temperature sensor for use with RT or WT thermostats	Page 119	£42.00
 RST3-IN	Adjustable room thermostat 16A	Page 110	£60.00
 RST3-TP	Tamperproof room thermostat 16A	Page 110	£80.00

For larger installations we recommend our PC control box – see pages 104-107

\*Tamperproof function available on these models



### Office

**Location:** Croydon, London

**Installed:** 24 x 300W radiant panels



## Aston Martin

**Location:** Bristol

**Installed:** 4 x 600W Radiant Ceiling Panels



# RADIANT CASSETTES

## What is a Longwave Radiant Cassette ?

A discrete energy efficient heater used to space heat large commercial premises with high ceilings such as sports halls, village halls and showrooms. Cassettes provide radiant comfort heat with no noise, draught or light output.



## Key Features

- Radiant heat without light output
- Robust steel case with white epoxy finish
- Ceiling mounting brackets supplied as standard
- Can be suspended
- Optional angle adjustable wall brackets



### ENERGY SAVING TIP

Cassette's radiant effect makes you feel warmer than the actual ambient air temp. This means you can set your thermostat 3-4°C lower.









## Radiant Cassettes

Model	kW	List Price
ESP2-12	1.2	£470.00
ESP2-18	1.8	£648.00
ESP2-24	2.4	£680.00
ESP2-30	3.0	£850.00
ESP2-36	3.6	£893.00
ESP2-B (optional wall bracket)		£56.00

## Technical

Model	kW	Volts	Dimensions (mm)			Recommended Mounting Height (m)		Weight (kg)
			H	W	D	Min	Max	
ESP2-12	1.2	230	60	1550	150	3.0	4.0	5.8
ESP2-18	1.8	230	60	1550	250	3.5	6.0	9.9
ESP2-24	2.4	230	60	1550	250	3.5	6.0	9.9
ESP2-30	3.0	230/400	60	1550	350	3.5	8.0	13.9
ESP2-36	3.6	230/400	60	1550	350	3.5	8.0	13.9

## Accessories

Model	Description	Details	List Price
 RT16	Programmable thermostat 16A	Page 112	£144.00
 RT26	Programmable thermostat 26A	Page 113	£177.00
 WT16	Wi-Fi thermostat 16A (download free app)	Page 114	£222.00
 WT26	Wi-Fi thermostat 26A (download free app)	Page 114	£269.00
 BBS	Optional remote-mounted 'black bulb' temperature sensor for use with RT or WT thermostats	Page 112-116	£73.00
 CON-32	Contactors 32A 3-pole	Page 125	£60.00
 CON-50	Contactors 50A 3-pole	Page 125	£78.00
 CON-80	Contactors 80A 3-pole	Page 125	£176.00
 ENCL-D	Enclosure for CON-32 and CON-50	Page 125	£32.00

For larger installations we recommend our PC control box – see pages 104-107



### Village Hall

**Location:** Farnham, Essex

**Installed:** 4 x 2.4kW Radiant Cassettes



## Bedford Timber Supplies

**Location:** Bedford

**Installed:** 6 x 3kW Radiant Cassettes



# LONGWAVE RADIANT HEATER CONTROL BOX



## What is a Longwave Radiant Heater Control Box ?

A control box that speeds up and simplifies multi longwave radiant heater installs. A typical PC control box installation will require less cable, less MCB's or RCB's and less junction boxes. It is also quicker to install as each circuit is individually fused. These control boxes also allow end users to program multiple heaters from one simple controller.





## Control Panel Features

- For use with ESP2 Radiant Cassettes and RP3 Radiant Ceiling Panels (see pages 96-99 and 100-103)
- Up to 24 heaters controlled from a single control box (depending on heater output)
- For large installations up to 10 control boxes can be connected using data cable
- Can receive a 230V signal directly from a BMS (PC-C1 controller not required)
- Robust steel enclosure

## Controller Features

- Connected to control box using data cable
- Integral thermostat
- Integral temperature sensor (can be used with remote-mounted sensor when required)
- 7-day programming (up to 6 events per day)
- Optimum start (optional)
- Adaptive stop – reduces temperature 'over/under shoot' improving both comfort and economy (optional)
- Button lock to prevent unauthorised adjustment (optional)

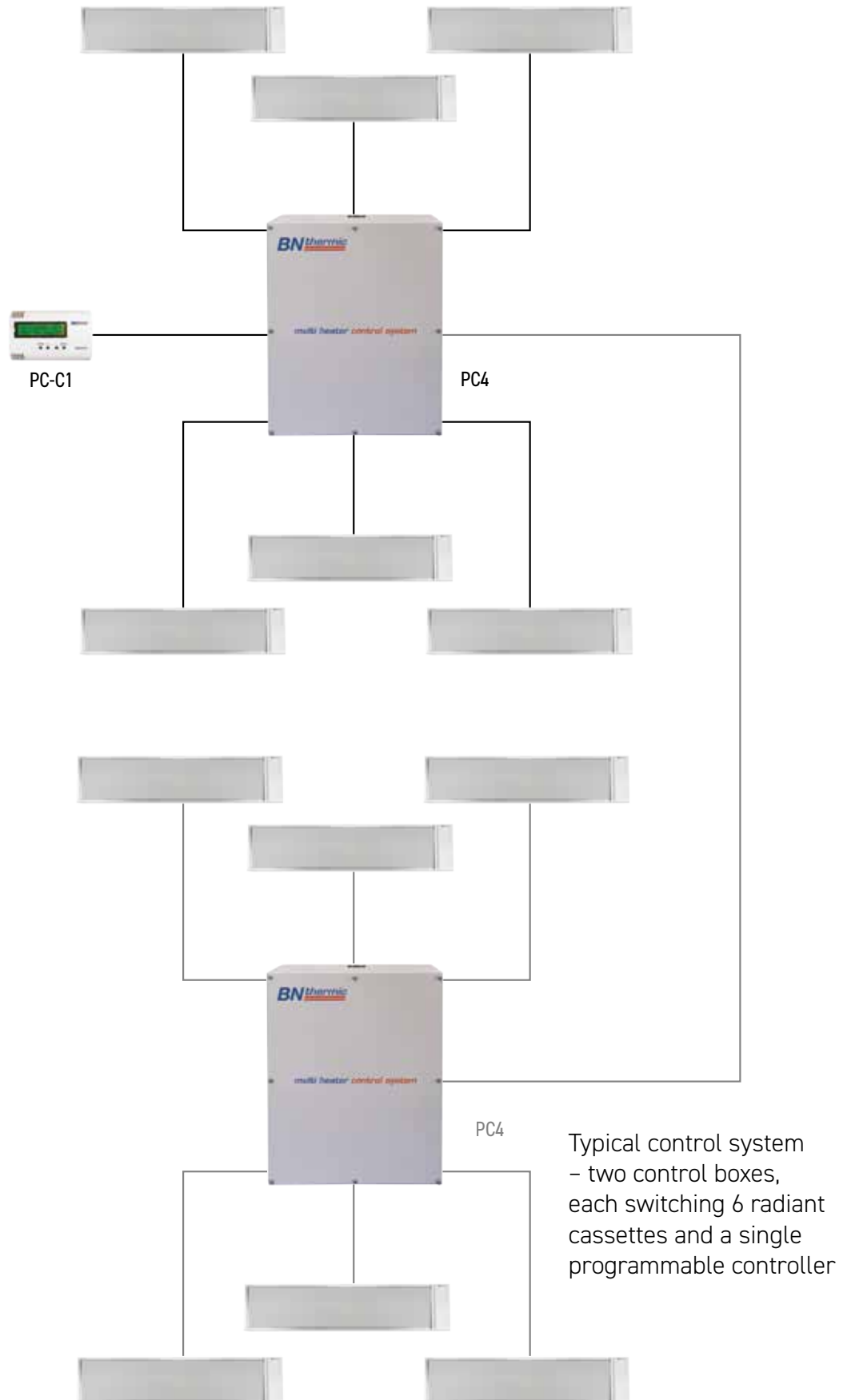





## Control Boxes

Model	Description	List Price Each
PC1	Control Box for 230V 1ph System	£760.00
PC2	Control Box for 230V 1ph System	£762.00
PC3	Control Box for 400V 3ph System	£768.00
PC4	Control Box for 400V 3ph System	£760.00
PC5	Control Box for 400V 3ph System	£768.00
PC-C1	Programmable Controller (see page 125)	£248.00

## Control Box Selection

Control Box	Voltage	Max Quantity of Heaters	Heater Model	kW per Heater
PC1	230V 1ph	6	ESP2-12	1.2kW
PC2	230V 1ph	12	RP3-06	0.6kW
	230V 1ph	24	RP3-03	0.3kW
PC3	400V 3ph & N	36	RP3-06	0.6kW
	400V 3ph & N	36	RP3-03	0.3kW
	400V 3ph & N	12	ESP2-18	1.8kW
	400V 3ph & N	12	ESP2-12	1.2kW
PC4	400V 3ph & N	6	ESP2-24	2.4kW
	400V 3ph & N	6	ESP2-30	3.0kW
PC5	400V 3ph & N	6	ESP2-36	3.6kW

## Ancillary System Components

Model	Description	List Price
 CXS	Optional remote-mounted temperature sensor	£42.00
 DX05	Cat5 cable terminated 5m	£10.00
 DX10	Cat5 cable terminated 10m	£15.00
 DX20	Cat5 cable terminated 20m	£23.00
JX1	Cat5 Cable Joiner	£5.50

Cat5 cable used to connect controller to a control box and to interconnect control boxes

## B16C – Basic Underfloor Heating Thermostat



Application	Underfloor heating
Adjustable Range	+5°C to +30°C
Mounting	Recessed into single-gang back box
Programmable Periods	5+2 or 7 days/4 events per day
Sensors	Integral air sensor with floor sensor supplied as standard
Switching Capacity	16A 230V
Voltage Supply	230V
Contacts	Single pole single throw
Dimensions	86mm (H) x 86mm (W) x 15mm (D) – when installed
Ingress protection	IP20
Special features	Optional open window detection Can be configured for 'air and floor sensor', 'floor sensor only' or 'air sensor only' Back-lit screen
<b>List Price</b>	<b>£69.00</b>

## W16C – Touchscreen/Wi-Fi Thermostat



Application	Underfloor heating
Adjustable Range	+5°C to +30°C
Mounting	Recessed into a single-gang box
Programmable Periods	5+2, 6+1 or 7 days/6 events per day
Sensors	Integral air sensor with floor sensor supplied as standard
Switching Capacity	16A 230V
Voltage Supply	230V
Contacts	Single pole single throw
Dimensions	86mm (H) x 86mm (W) x 16mm (D) when recessed
Ingress Protection	IP20
Special Features	Free app for iOS or Android phone Can be used without app Back-lit screen Optional open window detection
<b>List Prices</b>	<b>W16CW (white): £133.00</b> <b>W16CB (black): £133.00</b>

### T16C - Touchscreen Underfloor Heating Thermostat



CXSIP optional  
IP65 air sensor

Application	Underfloor heating
Adjustable Range	+5°C to +34°C
Mounting	Recessed into a single-gang back box
Programming Periods	7-day with no restriction of number of events per day
Sensors	Integral air sensor with floor sensor supplied as standard
Switching capacity	16A 230V
Voltage supply	230V
Contacts	Single pole, single throw
Dimensions	90mm (H) x 90mm (W) x 18mm (D) - when installed
Ingress protection	IP21
Special Features	Available in white, black or silver Can be configured for 'air and floor sensor' or 'floor sensor only' Screen colour can be changed Built-in energy use monitor Can be used with remote, wall mounted air sensor model CXSIP (IP65) Optional optimum start Optional open window detection
<b>List Prices</b>	<b>T16CW (white): £185.00</b> <b>T16CB (black): £198.00</b> <b>T16CS (silver): £198.00</b> <b>CXSIP (optional remote air sensor): £44.00</b>

### RAA21 - Basic Thermostat with frost setting



Application	Commercial and industrial heating
Adjustable range	+8°C to +30°C
Frost setting	+8°C
Mounting	Surface
Switching capacity	6A 230V
Voltage supply	230V
Contact	Single pole, double throw
Dimensions	96mm x 97mm x 35mm
Ingress protection	IP30
Special feature	Adjustable range can be reduced using setpoint limiters under the cover
<b>List Price</b>	<b>£43.00</b>

## RST3-IN - Standard Room Thermostat



Application	Commercial heating
Adjustable range	+5°C to +35°C
Mounting	Surface
Switching capacity	16A 230V
Voltage supply	230V
Contacts	Single pole, single throw
Dimensions	83mm x 83mm x 35mm
Ingress protection	IP30
Special features	Gas bellow/membrane improves control accuracy
Price	£60.00

## RST3-TP - Tamper-Resistant Room Thermostat



Application	Commercial heating
Adjustable range	+5°C to +35°C
Mounting	Surface
Switching Capacity	16A 230V
Voltage Supply	230V
Contacts	Single pole, single throw
Dimensions	83mm x 83mm x 45mm
Ingress protection	IP30
Special features	Gas bellow / membrane improves control accuracy Tamper resistant cover
List price	£80.00

## RST-RS - Tamperproof Rough Service Thermostat



Application	Industrial Heating
Adjustable range	+5°C to +30°C
Mounting	Surface
Tamper resistant	Yes
Switching capacity	20A 230V
Voltage supply	Non required
Contacts	Single pole, single throw
Dimensions	125mm x 125mm x 75mm
Special features	Supplied with 2 x M20 cable glands
List price	£143.00

### FST3-EX - Frost Thermostat (outdoor)



Application	Frost Protection
Adjustable range	-12°C to +26°C
Mounting	Surface
Tamper resistant	Yes
Switching capacity	20A 230V
Voltage supply	Single pole, single throw
Contacts	230V
Dimensions	125mm x 125mm x 75mm
Ingress protection	IP66
Special features	Supplied with 1 x M20 cable gland
List Price	£133.00

### FST-RS - Rough Service Frost Thermostat (indoor)



Application	Frost Protection
Adjustable Range	-12°C to +26°C
Mounting	Surface
Tamper resistant	Yes
Switching Capacity	20A 230V
Contacts	Single pole, single throw
Dimensions	125mm x 125mm x 75mm
Ingress protection	Indoor use only
Special features	Supplied with 2 x M20 cable glands
List price	£138.00

### PROSTAT2 - Programmable Thermostat



Application	Programmable temperature control in commercial premises
Programming	7 day or 5 + 2 days
Adjustable Range	+5°C to +35°C
Mounting	Surface
Switching capacity	6A 230V
Voltage supply	2 x AA batteries (supplied)
Contacts	Single pole, change over
Dimensions	127mm x 81mm x 28mm
Ingress protection	IP30
Special features	Up to 6 programmable events per day Temporary temperature override until next pre-set period Temperature lock – permanent temperature override until reset Delayed start, optimum start, optimum stop options
List Price	£121.00

## RD16 – Basic Programmable Thermostat (recessed)



CXS

BBS



CXSIP

BBSIP

Application	Commercial and industrial space heating
Adjustable range	+1°C to +45°C (default +5°C to +30°C)
Mounting	Recessed into a single-gang back box
Programmable periods	5+2 or 7 days/4 events per day
Sensor	Integral air sensor (optional remote sensors available)
Switching capacity	16A 230V
Voltage supply	230V
Contacts	Single pole single throw
Dimensions	86mm (H) x 86mm (W) x 15mm (D) – when installed
Ingress protection	IP20
Special features	Optional open window detection
List Price	RD16 Thermostat: £65.00
	<b>Optional Remote Sensors</b>
	CXS Air Sensor: £42.00
	CXSIP Air Sensor IP65: £44.00
	BBS Black Bulb Sensor: £73.00
	BBSIP Black Bulb Sensor IP65: £75.00

## RT16 Programmable Wall-Mounted Thermostat 16A



CXS

BBS



CXSIP

BBSIP

Application	Commercial or industrial space heating
Adjustable Range	+1°C to +45°C (default +5°C to +30°C)
Mounting	Surface mount
Programmable Periods	5+2 or 7 days/4 events per day
Sensors	Integral air sensor (can be used with remote-mounted temperature sensor)
Switching Capacity	16A 230V
Voltage Supply	230V
Contacts	Single pole single throw
Dimensions	120mm (H) x 94mm (W) x 57mm (D)
Case	Die-cast aluminium
Ingress protection	IP20
Special features	Optional open window detection Can be used with remote, wall-mounted sensor Supplied with 2 x M20 cable glands
List Price	RT16 Thermostat: £144.00
	<b>Optional Remote Sensors</b>
	CXS Air Sensor: £42.00
	CXSIP Air Sensor IP65: £44.00
	BBS Black Bulb Sensor: £73.00
	BBSIP Black Bulb Sensor IP65: £75.00



### RT26 Programmable Wall-Mounted Thermostat 26A



CXS

BBS

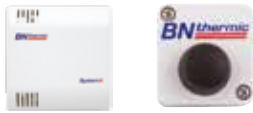

CXSIP

BBSIP

Application	Commercial or industrial space heating
Adjustable Range	+1°C to +45°C (default +5°C to +30°C)
Mounting	Surface mount
Programmable Periods	5+2 or 7 days/4 events per day
Sensors	Integral air sensor (can be used with remote-mounted temperature sensor)
Switching Capacity	26A 230V
Voltage Supply	230V
Contacts	Single pole single throw
Dimensions	125mm x 125mm x 90mm
Case	ABS Plastic
Ingress Protection	IP20
Special features	Optional open window detection Can be used with a remote, wall-mounted sensor Supplied with 2 x M20 cable glands
List Price	RT26 Thermostat: £177.00 <b>Optional Remote Sensors</b> CXs Air Sensor: £42.00 CXsIP Air Sensor IP65: £44.00 BBS Black Bulb Sensor: £73.00 BBSIP Black Bulb Sensor IP65: £75.00

### WD16 – Touchscreen/Wi-Fi Thermostat (recessed)



CXS

BBS



CXSIP

BBSIP

Application	Commercial and industrial space heating
Adjustable range	+5°C to +30°C
Mounting	Recessed into a single-gang back box
Programmable periods	5+2 or 7 days/6 events per day
Sensor	Integral air sensor (optional remote sensors available)
Switching capacity	16A 230V
Voltage supply	230V
Contacts	Single pole single throw
Dimensions	86mm (H) x 86mm (W) x 16mm (D) – when installed
Ingress protection	IP20
Special features	Free app for iOS or Android phone Can be used without app Back-lit screen Optional open window detection Supplied with 2 x M20 cable glands
List Price	WD16 Thermostat: £130.00 <b>Optional Remote Sensors</b> CXs Air Sensor: £42.00 CXsIP Air Sensor IP65: £44.00 BBS Black Bulb Sensor: £73.00 BBSIP Black Bulb Sensor IP65: £75.00





CXS

BBS

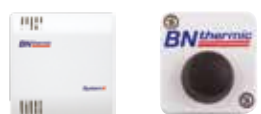

CXSIP

BBSIP



## WT16 - Touchscreen/Wi-Fi Thermostat 16A

Application	Commercial and industrial space heating
Adjustable range	+5°C to +30°C
Mounting	Surface mount
Programmable periods	5+2 or 7 days/6 events per day
Sensor	Integral air sensor (optional remote sensors available)
Switching capacity	16A 230V
Voltage supply	230V
Contacts	Single pole single throw
Dimensions	120mm (H) x 94mm (W) x 57mm (D)
Case material	Die-cast aluminium
Ingress protection	IP20
Special features	Free app for iOS or Android phone Can be used without app Back-lit screen Optional open window detection Supplied with 2 x M20 cable glands
List price	WT16 Thermostat: £222.00 <b>Optional Remote Sensors</b> CXs Air Sensor: £42.00 CXsIP Air Sensor IP65: £44.00 BBS Black Bulb Sensor: £73.00 BBSIP Black Bulb Sensor IP65: £75.00

## WT26 - Touchscreen/Wi-Fi Thermostat 26A



CXS

BBS

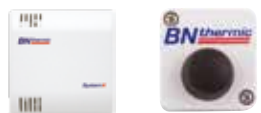

CXSIP

BBSIP



Application	Commercial and industrial space heating
Adjustable range	+5°C to +30°C
Mounting	Surface mount
Programmable periods	5+2 or 7 days/6 events per day
Sensor	Integral air sensor (optional remote sensors available)
Switching capacity	26A 230V
Voltage supply	230V
Contacts	Single pole single throw
Dimensions	125mm (H) x 125mm (W) x 90mm (D)
Case material	ABS plastic
Ingress protection	IP20
Special features	Free app for iOS or Android phone Can be used without app Back-lit screen Optional open window detection Supplied with 2 x M20 cable glands
List price	WT26 Thermostat: £269.00 <b>Optional Remote Sensors</b> CXs Air Sensor: £42.00 CXsIP Air Sensor IP65: £44.00 BBS Black Bulb Sensor: £73.00 BBSIP Black Bulb Sensor IP65: £75.00

### RST-HT High Temperature Room Thermostat



Application	Commercial and industrial heater control
Adjustable Range	+5°C to +50°C
Mounting	Surface mount
Switching Capacity	16A 230V
Voltage Supply	None required
Contacts	Single pole, single throw
Dimensions	125mm x 125mm x 75mm
Ingress Protection	IP66
Special features	Supplied with 2 x M20 cable glands
List Price	£153.00

### PROSTAT3 Tamper-Resistant Industrial Thermostat



PROSTAT3



CXS



BBS



CXSIP



BBSIP

Application	Industrial heater control
Adjustable Range	0°C to +30°C
Mounting	Surface
Switching Capacity	32A 230V
Voltage Supply	230V
Contacts	Single pole, single throw
Dimensions (H x W x D)	140mm x 124mm x 75mm
Ingress Protection	IP65
Sensor	Integral 'black bulb'
Special Features	Can be use with remote-mounted temperature sensor BBS (black bulb standard) BBSIP (black bulb IP65) or CXS (standard air sensor) Optional open window detection Supplied with 2 x M20 cable glands
List Price	PROSTAT3 Thermostat: £209.00 <b>Optional Remote Sensors</b> CXS Air Sensor: £42.00 CXSIP Air Sensor IP65: £44.00 BBS Black Bulb Sensor: £73.00 BBSIP Black Bulb Sensor IP65: £75.00

## PROSTAT4 Two-Temperature Tamper-Resistant Industrial Thermostat



PROSTAT4



CXS



BBS



CXSIP



BBSIP

Application	Industrial heater control where two temperature settings are required (e.g. comfort and frost-protection settings)
Adjustable Range - Setting One (Default)	0°C to +20°C
Adjustable Range - Setting Two	10°C to +30°C
Switching Capacity	32A 230V
Voltage Supply	230V
Contacts	Single pole, single throw
Dimensions (H x W x D)	140mm x 124mm x 78mm
Ingress Protection	IP65
Sensor	Integral 'black bulb'
Three methods to select Temperature Setting Two	<ol style="list-style-type: none"> <li>1- Push button on front face of thermostat activates built-in run-down timer (0-7.5 hours)</li> <li>2- Remote-mounted push button (CS-5) activates built-in run-down timer (0-7.5 hours)</li> <li>3- Remote-mounted volt-free programmable timer (PROTIM-7)</li> </ol>
Built-in Run-Down Timer Programmable Delay	Up to 7.5 hours
Special Features	<p>Front panel light indicates when Temperature Setting Two selected</p> <p>Can be use with remote-mounted temperature sensor BBS (black bulb standard) BBSIP (black bulb IP65) or CXS (standard air sensor)</p> <p>Optional open window detection</p> <p>Supplied with 2 x M20 cable glands</p>
List Price	<p>PROSTAT4 Thermostat: £222.00</p> <p><b>Optional Remote Sensors</b></p> <p>CXS Air Sensor: £42.00</p> <p>CXSIP Air Sensor IP65: £44.00</p> <p>BBS Black Bulb Sensor: £73.00</p> <p>BBSIP Black Bulb Sensor IP65: £75.00</p>

### THT Weatherproof Capillary Thermostat



Application	Control for pipe trace heating
Adjustable Range	+5°C to +50°C
Mounting	Surface mount
Switching Capacity	16A 230V
Voltage Supply	None required
Contacts	Single pole, single throw
Dimensions	125mm x 125mm x 75mm
Capillary Length	600mm approx. (including bulb)
Ingress Protection	IP66
Special features	Supplied with 2 x M20 cable glands
List Price	£160.00

### TXST-01 - ATEX Thermostat (hazardous gases only)



Approval	ATEX
Equipment Protection Level	Gb (gas)
Zones	Zones 1 and 2 (gas)
Group	Group IIC
Temperature Class	T6
Adjustable Range	0 to +40°C
Differential	4°C (+/- 2°C)
Temperature Sensing	Bulb and Capillary (stainless steel)
Cable Entries	2 x M20
Enclosure Material	Cast aluminium with black anodised finish
Mounting plate material	Stainless steel
Switching Capacity	16A 230V resistive load
Contacts	Single pole double throw (changeover)
Ingress protection	IP66
Dimensions	270mm (w) x 155mm (h) x 91mm (d)
Weight	5kg
List Price	£1043.00

## OUH3-DT



Application	Controlling OUH3 Industrial heaters
Adjustable Range	+5°C to 30°C
Mounting	Surface
Programmable Periods	7 Day, 6+1 Day or 5+2 Day (Default 5+2 Day)
Temperature Sensor	Internal air sensor
Remote Sensors (If required)	CXS, CXSIP, BBS and BBSIP (IP versions are IP65 rated)
Display	LCD + back light that operates when any button is pressed
Voltage Supply	230V (Fed from a 3A fused supply inside OUH3 Heater) (Battery back-up for settings)
Mode Switch	Heat / Off / Fan Only (Heat only on when thermostat allows)
Dimensions	125mm (H) x 132mm (W) x 90mm (D).
Case	ABS Plastic
Special Features	Facility for locking all thermostat buttons or all thermostat buttons except "On / Off" button. Supplied with 2 x M20 Cable Glands
List Price	£154.00

## OUH3-WIFI



Application	Controlling OUH3 Industrial heaters
Adjustable Range	+5°C to 30°C
Mounting	Surface
Programmable Periods	5+2 Day or 7 Days/6 events per day
Temperature Sensor	Internal air sensor
Remote Sensors (If required)	CXS, CXSIP, BBS and BBSIP (IP versions are IP65 rated)
Display	Touch Screen + back lit screen
Voltage Supply	230V (Fed from a 3A fused supply inside OUH3 Heater)
Mode Switch	Heat / Off / Fan Only (Heat only on when thermostat allows)
Dimensions	125mm (H) x 132mm (W) x 90mm (D).
Case	ABS Plastic
Special Features	Free app for iOS or Android phone Can be used without app Supplied with 2 x M20 Cable Glands
List Price	£211.00

### CX1 - Controller with thermostat



CX1  
with thermostat



CX2  
with tamper  
resistant  
thermostat



CX3  
without thermostat



CX6  
Programmable  
Controller

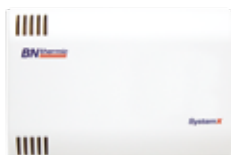

CX-BMS  
Module



CXS/CXSIP  
optional remote  
sensor for CX1, CX2  
or CX6

For use with	All heaters in System X range in any sequence
Maximum no. of heaters controlled	12
Thermostat range	5° to 30°C
Settings	on/off/high heat/low heat/fan only (summer use)
Connection to first heater	Cat5 cable
Mounting	Surface
Dimensions	120mm x 80 x 40mm
Special Feature	Open window detection
List price	£144.00

### CX2 - Controller with tamper-resistant thermostat

As CX1 except	Thermostat is tamper-resistant
Special Feature	Open window detection
List price	£147.00

### CX3 - Controller without thermostat

As CX1 except	Without built-in thermostat or open window detection
List price	£146.00

### CX6 - Programmable Controller

As CX1 except	7 day or 5 + 2 days programming Up to 6 programmable events per day Temporary temperature override until next pre-set period Temporary lock – permanent temperature override until reset Optimum start for enhanced economy (user selectable) Button lock to prevent unauthorised adjustment Back light (switches off automatically after programming or adjustment)
List price	£253.00

### CX-BMS - Connects SystemX to a BMS

As CX1 except	Without built-in thermostat or open-window detection Switches heaters on and off as directed by signal from BMS Requires volt-free signal (for a 230V signal a VI interface is required – see page 129)
List price	£137.00

### CXS - Optional Remote Sensor with IP rated option

Can be used with	CX1, CX2, CX6 and other BN Thermic control systems
Mounting	Surface
Dimensions	80mm x 80 x 34mm
Ingress protection	Standard model: IP 20 CXSIP: IP65
List price	CXS: £42.00 CXSIP: £44.00

### TS-7 - Soft Start Push Button Timer - 6kW



Application	Controlling halogen heaters (including patio heaters)
Mounting	Surface
Finish	Light grey
Time delay	5 minutes to 90 minutes
Switching capacity	6kW 230V (250W minimum)
Voltage supply	230V
Contacts	Single pole, single throw
Dimensions	124mm x 124mm x 78mm
Ingress protection	IP65
Special features	Constant light indicates 'heater on' Flashing light indicates last minute of operation Can be used with our PROTIM-7 timer or a volt free thermostat such as our PROSTAT2 Soft start switching prolongs halogen lamp life Supplied with 2 x M20 cable glands
List price	£205.00

### TS-7B - Soft Start Push Button Timer - 6kW



Application	Controlling halogen heaters (including patio heaters)
Mounting	Surface
Finish	Black
Time delay	5 minutes to 90 minutes
Switching capacity	6kW 230V (250W minimum)
Voltage supply	230V
Contacts	Single pole, single throw
Dimensions	124mm x 124mm x 78mm
Ingress protection	IP65
Special features	Constant light indicates 'heater on' Flashing light indicates last minute of operation Can be used with our PROTIM-7 timer or a volt free thermostat such as our PROSTAT2 Soft start switching prolongs halogen lamp life Supplied with 2 x M20 cable glands
List price	£205.00



### TS-8 - Push Button Timer - 7.2kW



Application	Controlling electric heaters including ceramic heaters, fan heaters Ideally suited for use with a contactor Not suitable for direct switching of halogen heater (i.e. only via contactor)
Mounting	Surface
Time Delay	5 minutes to 90 minutes
Switching Capacity	7.2kW 230V (no minimum)
Voltage Supply	230V
Contacts	Single pole, single throw
Dimensions	124mm x 124mm x 78mm
Ingress protection	IP65
Special features	Constant light indicates 'heater on' Flashing light indicates last minute of operation Can be used with our PROTIM-7 timer or a volt-free thermostat such as our PROSTAT2 Supplied with 2 x M20 cable glands
List price	TS-8 (Light grey finish): £207.00 TS-8B (Black finish): £207.00

### PROTIM-7 - Programmable Timer



Application	Ideal for use with a variety of commercial and industrial heating schemes
Programming	7day, 5 + 2 days or 24hour
Mounting	Surface
Maximum events per day	4
Switching Capacity	13A 230V (when switching halogen heaters this timer can be used in conjunction with our SSR soft start relay – see page 128)
Voltage Supply	230V
Dimensions	90 x 115 x 57mm
Ingress Protection	IP30
Special Features	Advance to next programme Boost (select 1 hour or 2 hours) Override – permanently on or permanently off Automatic summer update Battery back up Tough aluminium case
List price	£182.00

## CS-7 - Three Gang Switch for fan heater control



For use with	800 Series SCHG RH SMH CA
Settings	On/off/high heat/low heat/fan only (summer use)
Voltage supply	230V
Mounting	Surface
Dimensions	148 x 88 x 45mm
Ingress protection	IP30
List price	£98.00

## CS-2 - Two Gang Switch for halogen or ceramic heater control



For use with	HN3-30 and CH2-30 (EXCEPT LINEAR MODELS)
Settings	Full heat / 1/2 heat
Voltage supply	230V
Mounting	Surface
Dimensions	85 x 85 x 48mm
Ingress protection	IP30
List price	£78.00

## CS-3 - Three Gang Switch for halogen heater control



For use with	HN3-45 and HN3-60
Settings	Full heat / 2/3 heat / 1/3 heat
Voltage supply	230V
Mounting	Surface
Dimensions	146 x 85 x 48mm
Ingress protection	IP30
List price	£105.00

### CS-4 - Single Gang Switch for halogen or ceramic heater control



For use with	HN3-15, HN3-20, HN3-30, CH2-15, CH2-30 (4 kW MAX)
Settings	On/off
Voltage supply	230V
Mounting	Surface
Dimensions	85 x 85 x 48mm
Ingress protection	IP30
List price	£60.00

### CS-5 - Push Button



For use with	SSR soft start relay (see page 128)
Function	Triggers SSR's built-in run-down timer
Voltage supply	230V
Mounting	Surface
Dimensions	85 x 85 x 48mm
Ingress protection	IP30
List price	£60.00

### CS-6 - Six Gang Switch for multiple halogen or ceramic heater control



For use with	6 x HN3-15 or CH2-15 (settings: on/off) 6 x HN3-20 (settings on/off) 3 x HN3-30 or CH2-30 EXCEPT LINEAR MODELS (settings: 1.5kW/3kW/off) 2 x HN3-45 (settings: 1.5kW/3kW/4.5kW/off) 2 x HN3-60 (settings: 2kW/4kW/6kW/off)
Voltage supply	230V
Mounting	Surface
Dimensions	146mm x 146mm x 48mm
Ingress protection	IP30
Special features	A full set of adhesive labels supplied for all above options Individual switches selected to withstand halogen lamp inrush
List price	£162.00

### OUH3-S Switch for OUH3 industrial fan heater control



For use with	Any heater or group of heaters from the OUH3 range
Settings	On/off/fan only (summer use)
Voltage supply	230V
Mounting	Remote surface mounting or mounted onto an OUH3 heater
Dimensions	85 x 85 x 48mm
Ingress protection	IP30
List Price	£79.00



### HC-C1 Controller

Description	Manual controller for use with HC2 and HC3 control boxes
Settings (when used with HC2 control panel)	On /off/ ½ heat / full heat All heaters in a control group will function identically
Settings (when used with HC3 control panel)	On / off / ⅓ heat/ ⅔ heat/ full heat All heaters in a control group will function identically
Timer	Run-down timer programmable between 5 minutes and 2 hours Activated by optional HC-B push button
Supply	Separate voltage supply not required - supply provided by the control box
Dimensions	120mm x 80mm x 40mm
List Price	£146.00



### HC-B Push Button

Description	Push button for use with HC-C1 controller
Function	Activates HC-C1 controller's run-down timer
Supply	Separate voltage supply not required Supply provided by the controller
Dimensions	80mm x 80mm x 34mm
Features	Connection to controller via 150mm long pre-wired cable with 4-way plug Constant light indicates 'heaters on' Flashing light indicates last minute of operation
List Price	£59.00



### HC-CRS Controller - Rough Service

Description	Manual controller for use with HC2 and HC3 control boxes
Settings (when used with HC2 control panel)	On /off/ ½ heat / full heat All heaters in a control group will function identically
Settings (when used with HC3 control panel)	On / off / ⅓ heat/ ⅔ heat/ full heat All heaters in a control group will function identically
Voltage Supply	Separate voltage supply not required - supply provided by the control box
Dimensions	125mm x 125mm x 75mm (90mm including knob)
Ingress protection	IP66
Special features	Includes M20 Cable gland that has a split bush allowing pre-made Cat5 cables to be used
List Price	£153.00

### HC-TMRS Controller - Rough Service



Description	Manual controller for use with HC2 and HC3 control boxes
Settings (when used with HC2 control panel)	On / off / ½ heat / full heat, once run down timer activated
Settings (when used with HC3 control panel)	All heaters in a control group will function identically On / off / ⅓ heat / ⅔ heat / full heat, once run down timer activated
Count down time	All heaters in a control group will function identically 5 mins – 2 Hours (tamper resistant)
Voltage Supply	Separate voltage supply not required - supply provided by the control box
Dimensions	125mm x 125mm x 75mm (90mm including knob)
Ingress protection	IP66
Special features	Constant light indicates 'heaters on' Flashing light indicates last minute of operation Includes M20 Cable gland that has a split bush allowing pre-made Cat5 cables to be used
List Price	£181.00

### PC-C1 Controller



CXS/CXSIP

Description	Programmable controller for use with PC control boxes
Adjustable range	+5°C to +30°C
Programmable periods	5+2 or 7 days/6 events per day
Supply	Separate voltage supply not required - supply provided by the control box
Dimensions	120mm x 80mm x 40mm
Special features	Optional adaptive start Optional adaptive stop Optional screen locks
List Price	PC-C1 controller: £248.00 CXs optional remote sensor: £42.00 CXsIP optional remote sensor IP65: £44.00

### Contactors



CON-32



ENCL-D Enclosure

Model	Poles	Amps per Pole	Max kW per Pole @230V	List price
CON-32	3	32	7	£60.00
CON-50	3	50	11.5	£78.00
CON-80	3	80	18	£176.00
ENCL-D	Enclosure for CON-32 and CON-50: 175mm x 125mm x 175mm high			£32.00

Enclosure comes complete with DIN rail for quick fitting of contactor.

CON-50



CON-80





### WH-402 - Movement Sensor

Application	Controlling halogen heaters (including patio heaters) and ceramic heaters
Mounting	Surface
Switching capacity	10A 230V
Voltage supply	230V
Sensing range	12m/180° (both distance and angle can be reduced)
Time delay	5 seconds to 18 minutes (adjustable)
Dimensions	65mm x 83mm x 115mm
Ingress protection	IP55
List price	£130.00



### VR-2 - Dimmer

Application	Controlling halogen heaters (including patio heaters) and ceramic heaters
Mounting	Surface
Output adjustment	30% to 100%
Switching capacity	13A 230V (halogen heaters up to 3kW)
Voltage supply	230V
Contacts	Single pole, single throw
Dimensions	115mm x 90mm x 58mm
Ingress protection	IP55
Special features	Definite click to off
List price	£184.00



### RB26 Relay Box

Application	Quiet switching of loads up to 6kW 230V Ideal for underfloor heating
Mounting	Surface
Switching Capacity	26A
Voltage Supply	230V
Dimensions	124mm x 124mm x 78mm
Ingress Protection	IP21
Special features	Much quieter than the equivalent contactor Internal 1A fuse to protect thermostat/control circuit Supplied with 2 x M20 cable glands Up to 6 relay boxes can be linked
List price	£101.00

### SSR - Soft Start Relay



Application	Recommended for switching halogen heaters, including patio heaters, rather than a conventional contactor. Also suitable for ceramic heaters
Mounting	Surface
Switching capacity	6kW 230V (250W minimum)
Voltage supply	230V
Contacts	Single pole, single throw
Integral Timer	Optional feature – time delay 5 to 90 minutes
Dimensions	124mm x 124mm x 78mm
Ingress protection	IP66
Use with	CS-4 for manual on/off (see page 124) CS-5 to trigger integral timer (see page 125) PROTIM-7 for programmable control (see page 123) PROSTAT2 for programmable thermostatic control ONLY USE WITH ZERO VOLT DEVICES
Special features	Soft start switching prolongs halogen lamp life Reduced strain on MCB Supplied with 2 x M20 cable glands
List price	£214.00

### DSU-2R Fan Speed Regulator



Application	Controlling BN Thermic DSU3-40 and DSU3-50 Destratification Units (Not suitable for DSU3-45)
Voltage supply	230V
Mounting	Surface
Maximum load	2.5A (one regulator per unit)
Adjustment	30% to 100%
Dimensions	124mm x 124mm x 95mm (including knob)
Special features	Click to off Supplied with 2 x M20 cable glands
List price	£170.00

### VI Interface



Function	Converts a 230V signal to a volt-free signal
Typical Applications	Allows a variety of control devices to be integrated into SystemX heating schemes Allows a movement sensor such as the WH-402 to switch an SSR soft start relay
Mounting	Surface
Dimensions	80mm x 80mm x 34mm
List price	£60.00

# A-Z Price List

Model	Description	List Price	Model	Description	List Price
830	Wall / Overdoor Heater 3kW	395.00	CS-6	Halogen Heater Control Switch - 6 Lamps	162.00
830B	Black - Wall / Overdoor Heater 3kW	395.00	CS-7	Control Switch (Heat 1 and 2, Fan Only)	98.00
860	Wall / Overdoor Heater 6kW	638.00	CX1	SystemX Switch with Thermostat	144.00
860B	Black - Wall / Overdoor Heater 6kW	638.00	CX2	SystemX Switch + Hidden Thermostat	147.00
890	Overdoor Heater 9kW	1,015.00	CX3	SystemX Switch without Thermostat	146.00
890B	Black - Overdoor Heater 9kW	1,015.00	CX6	SystemX Programmable Controller	253.00
830T	Wall / Overdoor Heater 3kW + Thermostat	520.00	CX-BMS	BMS Module System X (Volt-Free signal)	137.00
830TB	Black - Heater 3kW + Thermostat	520.00	CXS	SystemX Remote Temperature Sensor	42.00
860T	Wall / Overdoor Heater 6kW + Thermostat	775.00	CXSIP	IP65 SystemX Remote Temperature Sensor	44.00
860TB	Black - Heater 6kW + Thermostat	775.00	DSU-2R	Fan Speed Regulator	170.00
890T	Overdoor Heater 9kW + Thermostat	1,135.00	DSU3-40	Destratification Unit 3800m <sup>3</sup> /h	897.00
890TB	Black - Overdoor Heater 9kW + Thermostat	1,135.00	DSU3-45	Destratification Unit 5600m <sup>3</sup> /h	949.00
AL-50	Aluminium Tape 45m x 48mm	17.00	DSU3-50	Destratification Unit 7650m <sup>3</sup> /h	1,130.00
B16C	Programmable Underfloor Thermostat	69.00	DX05	Cat5 Cable 5m Terminated - White	10.00
BBS	Black Bulb Sensor	73.00	DX10	Cat5 Cable 10m Terminated - White	15.00
BBSIP	Black Bulb Sensor IP65	75.00	DX-10B	Cat5 Cable 10m Terminated - Black	15.00
CAD-60	Commercial Air Curtain 6kW	875.00	DX20	Cat5 Cable 20m Terminated - White	23.00
CAD-90	Commercial Air Curtain 9kW	909.00	EHC-012	Heating Cable 0.7-1m <sup>2</sup> 0.12kW	75.00
CAH-180	Commercial Air Curtain 18kW	1,603.00	EHC-020	Heating Cable 1.1-1.5m <sup>2</sup> 0.2kW	92.00
CAS-30	Commercial Air Curtain 3kW	570.00	EHC-025	Heating Cable 1.6-2m <sup>2</sup> 0.25kW	102.00
CAS-45	Commercial Air Curtain 4.5kW	582.00	EHC-032	Heating Cable 2.1-2.5m <sup>2</sup> 0.32kW	117.00
CAT-135	Commercial Air Curtain 13.5kW	1,200.00	EHC-040	Heating Cable 2.6-2.9m <sup>2</sup> 0.4kW	128.00
CAT-90	Commercial Air Curtain 9kW	1,088.00	EHC-045	Heating Cable 3-3.3m <sup>2</sup> 0.45kW	148.00
CH2-15	Ceramic Heater 1.5kW Ivory	320.00	EHC-052	Heating Cable 3.4-3.8m <sup>2</sup> 0.52kW	151.00
CH2-15B	Ceramic Heater 1.5kW Black	320.00	EHC-060	Heating Cable 3.9-4.5m <sup>2</sup> 0.6kW	187.00
CH2-30	Ceramic Heater 3kW Ivory	488.00	EHC-075	Heating Cable 4.6-6m <sup>2</sup> 0.75kW	200.00
CH2-30B	Ceramic Heater 3kW Black	488.00	EHC-095	Heating Cable 6.1-7.5m <sup>2</sup> 0.95kW	235.00
CH2-30L	Ceramic Heater Linear 3kW Ivory	488.00	EHC-110	Heating Cable 7.6-8.5m <sup>2</sup> 1.1kW	292.00
CH2-30LB	Ceramic Heater Linear 3kW Black	488.00	EHC-130	Heating Cable 8.6-10m <sup>2</sup> 1.3kW	322.00
CON-32	Contacto 32A 3 pole	60.00	EHC-170	Heating Cable 10.1-13m <sup>2</sup> 1.7kW	397.00
CON-50	Contacto 50A 3 pole	78.00	EHC-200	Heating Cable 13.1-15.5m <sup>2</sup> 2kW	516.00
CON-80	Contacto 80A 3 pole	176.00	EHM-R-KIT	Heating Cable Repair Kit	41.00
CRJ-10	Self Regulating Cable 10W/m (By m)	16.00	ENCL-D	Contacto Enclosure Type D	32.00
CRJ-10+50	Self Regulating Cable 10W/m (By m)	15.00	ESP2-09	Radiant Cassette 0.9kW 230V	454.00
CRJ-25	Self Regulating Cable 25W/ m (By m)	28.00	ESP2-12	Radiant Cassette 1.2kW 230V	470.00
CRJ-25+50M	Self Regulating Cable 25W/ m (By m)	27.00	ESP2-18	Radiant Cassette 1.8kW 230V	648.00
CRJ-40EX	Self Regulating Cable 40W/m ATEX (By m)	28.00	ESP2-24	Radiant Cassette 2.4kW 230V	680.00
CRJ-40EX+50M	Self Regulating Cable 40W/m ATEX (By m)	27.00	ESP2-30	Radiant Cassette 3kW 230V or 400V	850.00
CRJ-S	Splice / Tee Kit For CRJ Cable	24.00	ESP2-36	Radiant Cassette 3.6kW 230V or 400V	893.00
CRJ-T1	Termination Kit For CRJ Cable	23.00	ESP2-B	Wall Brackets for ESP2 Series (Pair)	56.00
CS-2	Halogen Heater Control Switch - 2 Lamps	78.00	ETH-10	Terrace Heater 1kW	472.00
CS-3	Halogen Heater Control Switch - 3 Lamps	105.00	ETH-15	Terrace Heater 1.5kW	554.00
CS-4	Halogen Heater Control Switch - 1 Lamp	60.00	F140-010	Foil Heating Mat 1.0m <sup>2</sup> 140W/m <sup>2</sup>	89.00
CS-5	Push Button Switch 10A	60.00	F140-015	Foil Heating Mat 1.5m <sup>2</sup> 140W/m <sup>2</sup>	125.00



Model	Description	List Price	Model	Description	List Price
F140-020	Foil Heating Mat 2.0m <sup>2</sup> 140W/m <sup>2</sup>	146.00	HN3-60M	Halogen Heater 6kW Ivory Magic Lamp	800.00
F140-030	Foil Heating Mat 3.0m <sup>2</sup> 140W/m <sup>2</sup>	194.00	HSK	Suspension Kit (HN & CH Series)	10.00
F140-040	Foil Heating Mat 4.0m <sup>2</sup> 140W/m <sup>2</sup>	255.00	HWP2-2B	Patio Heater 2kW Black	260.00
F140-050	Foil Heating Mat 5.0m <sup>2</sup> 140W/m <sup>2</sup>	296.00	HWP2-2BM	Patio Heater 2kW Black - Magic Lamp	315.00
F140-060	Foil Heating Mat 6.0m <sup>2</sup> 140W/m <sup>2</sup>	345.00	HWP2-2W	Patio Heater 2kW White	260.00
F140-070	Foil Heating Mat 7.0m <sup>2</sup> 140W/m <sup>2</sup>	412.00	HWP2-2WM	Patio Heater 2kW White- Magic Lamp	315.00
F140-080	Foil Heating Mat 8.0m <sup>2</sup> 140W/m <sup>2</sup>	445.00	HWP2-3B	Patio Heater 3kW Black	368.00
F140-090	Foil Heating Mat 9.0m <sup>2</sup> 140W/m <sup>2</sup>	508.00	HWP2-3BM	Patio Heater 3kW Black - Magic Lamp	555.00
F140-100	Foil Heating Mat 10.0m <sup>2</sup> 140W/m <sup>2</sup>	554.00	HWP2-3W	Patio Heater 3kW White	368.00
F140-120	Foil Heating Mat 12.0m <sup>2</sup> 140W/m <sup>2</sup>	647.00	HWP2-3WM	Patio Heater 3kW White - Magic Lamp	555.00
F140-140	Foil Heating Mat 14.0m <sup>2</sup> 140W/m <sup>2</sup>	796.00	HWP2-45B	Patio Heater 4.5kW Black	520.00
F-BOARD-10	Insulated Tile Backer Board 10mm	29.00	HWP2-45BM	Patio Heater 4.5kW Black Magic Lamp	750.00
F-BOARD-6	Insulated Tile Backer Board 6mm	26.00	HWP2-B	Patio Heater 1.5kW Black	218.00
FST3-EX	Frost Thermostat 20A External Use IP66	133.00	HWP2-BM	Patio Heater 1.5kW Black - Magic Lamp	310.00
FST-RS	Frost Thermostat 20A Rough Service	138.00	HWP2-S	Patio Heater 1.5kW Silver	218.00
HC2	Halogen Heater Control Box (2 lamp)	760.00	HWP2-SM	Patio Heater 1.5kW Silver - Magic Lamp	310.00
HC3	Halogen Heater Control Box (3 lamp)	760.00	HWP2-W	Patio Heater 1.5kW White	218.00
HC-B	Halogen Heater Wall Timer Button	59.00	HWP2-WM	Patio Heater 1.5kW White - Magic Lamp	310.00
HC-C1	Halogen Heater Wall Control Switch	146.00	I-BOARD-6	Insulation Board 0.5m <sup>2</sup>	6.50
HC-CRS	HC Controller IP65 - Rough Service	153.00	I-PACK-6	Insulation Pack 9.76m <sup>2</sup>	48.00
HC-TMRS	HC Controller+ Timer IP65- Rough Service	181.00	JX1	Cat5 Joiner / Coupler	5.50
HN3-15	Halogen Heater 1.5kW Ivory	260.00	LC110	Low Level Convectector 750W 110V	249.00
HN3-15B	Halogen Heater 1.5kW Black	260.00	LHT	High Adhesive Tape 50m x 50mm	16.00
HN3-15BM	Halogen Heater 1.5kW Black Magic Lamp	320.00	M150-005	Heating Mat 0.5m <sup>2</sup> 150W/m <sup>2</sup>	63.00
HN3-15M	Halogen Heater 1.5kW Ivory Magic Lamp	320.00	M150-010	Heating Mat 1.0m <sup>2</sup> 150W/m <sup>2</sup>	70.00
HN3-20	Halogen Heater 2kW Ivory	271.00	M150-015	Heating Mat 1.5m <sup>2</sup> 150W/m <sup>2</sup>	93.00
HN3-20B	Halogen Heater 2kW Black	271.00	M150-020	Heating Mat 2.0m <sup>2</sup> 150W/m <sup>2</sup>	124.00
HN3-20BM	Halogen Heater 2kW Black Magic Lamp	325.00	M150-025	Heating Mat 2.5m <sup>2</sup> 150W/m <sup>2</sup>	132.00
HN3-20M	Halogen Heater 2kW Ivory Magic Lamp	325.00	M150-030	Heating Mat 3.0m <sup>2</sup> 150W/m <sup>2</sup>	155.00
HN3-30	Halogen Heater 3kW Ivory	420.00	M150-035	Heating Mat 3.5m <sup>2</sup> 150W/m <sup>2</sup>	177.00
HN3-30B	Halogen Heater 3kW Black	420.00	M150-040	Heating Mat 4.0m <sup>2</sup> 150W/m <sup>2</sup>	210.00
HN3-30BM	Halogen Heater 3kW Black Magic Lamp	510.00	M150-045	Heating Mat 4.5m <sup>2</sup> 150W/m <sup>2</sup>	222.00
HN3-30L	Halogen Heater Linear 3kW Ivory	420.00	M150-050	Heating Mat 5.0m <sup>2</sup> 150W/m <sup>2</sup>	242.00
HN3-30LB	Halogen Heater Linear 3kW Black	420.00	M150-060	Heating Mat 6.0m <sup>2</sup> 150W/m <sup>2</sup>	288.00
HN3-30LBM	Halogen Heater Linear 3kW Black Magic	510.00	M150-070	Heating Mat 7.0m <sup>2</sup> 150W/m <sup>2</sup>	313.00
HN3-30LM	Halogen Heater Linear 3kW Ivory Magic	510.00	M150-080	Heating Mat 8.0m <sup>2</sup> 150W/m <sup>2</sup>	331.00
HN3-30M	Halogen Heater 3kW Ivory Magic Lamp	510.00	M150-090	Heating Mat 9.0m <sup>2</sup> 150W/m <sup>2</sup>	362.00
HN3-45	Halogen Heater 4.5kW Ivory	620.00	M150-100	Heating Mat 10.0m <sup>2</sup> 150W/m <sup>2</sup>	389.00
HN3-45B	Halogen Heater 4.5kW Black	620.00	M150-110	Heating Mat 11.0m <sup>2</sup> 150W/m <sup>2</sup>	442.00
HN3-45BM	Halogen Heater 4.5kW Black Magic Lamp	748.00	M150-120	Heating Mat 12.0m <sup>2</sup> 150W/m <sup>2</sup>	484.00
HN3-45M	Halogen Heater 4.5kW Ivory Magic Lamp	748.00	M150-140	Heating Mat 14.0m <sup>2</sup> 150W/m <sup>2</sup>	536.00
HN3-60	Halogen Heater 6kW Ivory	698.00	M150-160	Heating Mat 16.0m <sup>2</sup> 150W/m <sup>2</sup>	610.00
HN3-60B	Halogen Heater 6kW Black	698.00	M200-010	Heating Mat 1.0m <sup>2</sup> 200W/m <sup>2</sup>	77.00
HN3-60BM	Halogen Heater 6kW Black Magic Lamp	800.00	M200-015	Heating Mat 1.5m <sup>2</sup> 200W/m <sup>2</sup>	103.00

# A-Z Price List

Model	Description	List Price	Model	Description	List Price
M200-020	Heating Mat 2.0m <sup>2</sup> 200W/m <sup>2</sup>	131.00	PF-L	Caution Label pack of 10	9.50
M200-030	Heating Mat 3.0m <sup>2</sup> 200W/m <sup>2</sup>	163.00	PF-T	Flame Retardant Fixing Tape 33m x 19mm	5.00
M200-040	Heating Mat 4.0m <sup>2</sup> 200W/m <sup>2</sup>	215.00	PH30	Pew Heater 300W	180.00
M200-050	Heating Mat 5.0m <sup>2</sup> 200W/m <sup>2</sup>	257.00	PH45	Pew Heater 450W	204.00
M200-060	Heating Mat 6.0m <sup>2</sup> 200W/m <sup>2</sup>	314.00	PH65	Pew Heater 650W	223.00
M200-070	Heating Mat 7.0m <sup>2</sup> 200W/m <sup>2</sup>	357.00	PHB	Pew Heater - Hanging Brackets (Pair)	40.00
M200-080	Heating Mat 8.0m <sup>2</sup> 200W/m <sup>2</sup>	436.00	PHF	Pew Heater - Floor Brackets (Pair)	34.00
M200-090	Heating Mat 9.0m <sup>2</sup> 200W/m <sup>2</sup>	473.00	PROSTAT2	7 Day Programmable Thermostat	121.00
M200-100	Heating Mat 10.0m <sup>2</sup> 200W/m <sup>2</sup>	585.00	PROSTAT3	Tamper-Resistant Industrial Thermostat	209.00
MD3-29	Mirror Demister Pad 230V 16W (300/290)	55.00	PROSTAT4	Two-Temperature Tamper-Resistant	222.00
MD3-49	Mirror Demister Pad 230V 27W (300/490)	63.00	PROTIM-7	7 Day Programmable Timer	182.00
MD3-73	Mirror Demister Pad 230V 40W (300/730)	72.00	PW-01	Pipe-Freeze Protection Kit 1m	102.00
MD3-97	Mirror Demister Pad 230V 54W (300/970)	81.00	PW-02	Pipe-Freeze Protection Kit 2m	111.00
MD3-125	Mirror Demister Pad 230V 69W (300/1250)	93.00	PW-03	Pipe-Freeze Protection Kit 3m	123.00
MD3-149	Mirror Demister Pad 230V 83W (300/1490)	97.00	PW-04	Pipe-Freeze Protection Kit 4m	129.00
MD5-29	Mirror Demister Pad 230V 27W (500/290)	60.00	PW-06	Pipe-Freeze Protection Kit 6m	140.00
MD5-49	Mirror Demister Pad 230V 46W (500/490)	71.00	PW-10	Pipe-Freeze Protection Kit 10m	145.00
MD5-73	Mirror Demister Pad 230V 69W (500/730)	81.00	PW-14	Pipe-Freeze Protection Kit 14m	150.00
MD5-97	Mirror Demister Pad 230V 92W (500/970)	93.00	PW-21	Pipe-Freeze Protection Kit 21m	151.00
MD5-125	Mirror Demister Pad 230V 119W (500/1250)	107.00	PW-30	Pipe-Freeze Protection Kit 30m	180.00
MD5-149	Mirror Demister Pad 230V 142W (500/1490)	116.00	PW-42	Pipe-Freeze Protection Kit 42m	208.00
MD7-29	Mirror Demister Pad 230V 38W (700/290)	66.00	RAA21	Mechanical Room Thermostat 6 Amp	43.00
MD7-49	Mirror Demister Pad 230V 65W (700/490)	77.00	RB26	Relay Box 26A	101.00
MD7-73	Mirror Demister Pad 230V 98W (700/730)	90.00	RD16	Room Wall Thermostat - Recessed	65.00
MD7-97	Mirror Demister Pad 230V 131W (700/970)	105.00	RH-20	Recessed Ceiling/Bulkhead Heater 2kW	329.00
MD7-125	Mirror Demister Pad 230V 169W (700/1250)	124.00	RH-30	Recessed Ceiling/Bulkhead Heater 3kW	435.00
MD7-149	Mirror Demister Pad 230V 201W (700/1490)	134.00	RH-60	Recessed Ceiling/Bulkhead Heater 6kW	802.00
OUH3-03	Industrial Fan Heater 3kW	1,186.00	RL15CW	Infrared Lamp IP55 Frosted 1.5kW 230V	64.00
OUH3-06	Industrial Fan Heater 6kW	1,239.00	RL15GF	Infrared Lamp Gold 1.5kW 230V SK15	78.00
OUH3-09	Industrial Fan Heater 9kW	1,326.00	RL15GW	Infrared Lamp IP55 Gold 1.5kW 230V	81.00
OUH3-15	Industrial Fan Heater 15kW	1,834.00	RL15GW/3	Infrared Lamp IP55 Gold 1.5kW 230V	81.00
OUH3-20	Industrial Fan Heater 20kW	1,968.00	RL15GW/4	Infrared Lamp IP55 Gold 1.5kW 230V	81.00
OUH3-25	Industrial Fan Heater 25kW	1,999.00	RL15MF	Infrared Lamp Magic 1.5kW SK15 230V	140.00
OUH3-40	Industrial Fan Heater 40kW	2,998.00	RL15MW	Infrared Lamp Magic IP55 1.5kW 230V	151.00
OUH3-DT	Thermostat + Control Switch for OUH3's	154.00	RL15MW/3	Infrared Lamp Magic IP55 1.5kW 230V	151.00
OUH3-HK	Hanging Kit for OUH3 Heaters	12.00	RL15MW/4	Infrared Lamp IP55 Magic 1.5kW 230V	151.00
OUH3-S	Control Switch for OUH3 Fan Heaters	79.00	RL20GF	Infrared Lamp Gold 2kW 230V SK15	80.00
OUH3-WIFI	WiFi Thermostat + Control Switch- OUH3's	211.00	RL20GW	Infrared Lamp IP55 Gold 2kW 230V	86.00
PC1	ESP2 Control Box 230V 1ph	760.00	RL20MF	Infrared Lamp Magic 2kW SK15 230V	140.00
PC2	RP Control Box 230V 1ph	762.00	RL20MW	Infrared Lamp Magic IP55 2kW 230V	155.00
PC3	RP + ESP Control Box 400V 3ph	768.00	RP3-03	Radiant Ceiling Panel (592 x 592) 300W	260.00
PC4	ESP2-24/30 Control Box 400V 3ph	760.00	RP3-06	Radiant Ceiling Panel (1192 x 592) 600W	375.00
PC5	ESP2-36 Control Box 400V 3ph	768.00	RST3-IN	Room Thermostat 16A	60.00
PC-C1	Programmable Controller	248.00	RST3-TP	Room Thermostat 16A Tamperproof	80.00

Model	Description	List Price	Model	Description	List Price
RST-HT	Thermostat IP66 5°C to 50°C 16A	153.00	TXG-01	Guard For TXT Heater 740mm	75.00
RST-RS	Thermostat 5°C - 30°C 20A Rough Service	143.00	TXG-02	Guard For TXT Heater 1350mm	92.00
RT16	Programmable Wall Thermostat 16A	144.00	TXST-01	Atex Thermostat 16A EPL Gb	1,043.00
RT26	Programmable Wall Thermostat 26A	177.00	TXT3-05	Atex Tubular Heater 500W	2,002.00
SCHG-30	Ceiling Grid Heater 3kW	393.00	TXT3-10	Atex Tubular Heater 1kW	2,077.00
SCHG-30T	Ceiling Grid Heater 3kW with Thermostat	568.00	TXT3-15	Atex Tubular Heater 1.5kW	2,286.00
SCHG-45	Ceiling Grid Heater 4.5kW	460.00	VI	Interface (230V to Volt-Free)	60.00
SCHG-45T	Ceiling Grid Heater 4.5kW + Thermostat	605.00	VR-2	Dimmer IP55 13A	184.00
SCHG-60	Ceiling Grid Heater 6kW	650.00	W16CB	WiFi Underfloor Thermostat - Black	133.00
SMH-30	Surface Mount Heater 3kW	410.00	W16CW	WiFi Underfloor Thermostat - White	133.00
SMH-30B	Surface Mount Heater 3kW - Black	410.00	WD16	Wi-Fi Wall Thermostat - Recessed	130.00
SMH-30T	Surface Mount Heater 3kW with Thermostat	550.00	WH-402	Movement Sensor IP55 16A	130.00
SMH-45	Surface Mount Heater 4.5kW	450.00	WT16	WiFi Wall Thermostat 16A	222.00
SMH-45T	Surface Mount Heater 4.5kW + Thermostat	590.00	WT26	WiFi Wall Thermostat 26A	269.00
SMH-60	Surface Mount Heater 6kW	680.00	XAD-60	System X Commercial Air Curtain 6kW	988.00
SSR	Soft Start Relay 6kW	214.00	XAD-90	System X Commercial Air Curtain 9kW	1,038.00
SWD-A-500	Tubular Heater 0.5kW + Thermostat	629.00	XAH-180	System X Commercial Air Curtain 18kW	1,938.00
SWD-A-1000	Tubular Heater 1kW + Thermostat	718.00	XAS-30	System X Commercial Air Curtain 3kW	684.00
SWD-A-1500	Tubular Heater 1.5kW + Thermostat	842.00	XAS-45	System X Commercial Air Curtain 4.5kW	697.00
SWD-A-2000	Tubular Heater 2kW + Thermostat	915.00	XAT-135	System X Commercial Air Curtain 13.5kW	1,399.00
SWD-A-3000	Tubular Heater 3kW + Thermostat	1,220.00	XAT-90	System X Commercial Air Curtain 9kW	1,216.00
SWD-U-500	Tubular Heater 0.5kW	453.00	XC-30	SystemX Ceiling Grid Heater 3kW	523.00
SWD-U-1000	Tubular Heater 1kW	543.00	XC-45	SystemX Ceiling Grid Heater 4.5kW	606.00
SWD-U-1500	Tubular Heater 1.5kW	655.00	XC-60	SystemX Ceiling Grid Heater 6kW	789.00
SWD-U-2000	Tubular Heater 2kW	748.00	XD-30	SystemX Wall / Overdoor Heater 3kW	590.00
SWD-U-3000	Tubular Heater 3kW	1,037.00	XD-60	SystemX Wall / Overdoor Heater 6kW	859.00
SWD-U-4000	Tubular Heater 4kW	1,435.00	XD-90	SystemX Wall / Overdoor Heater 9kW	1,122.00
SWD-U-500-1	Tubular Heater 0.5kW 110V	508.00	XR-20	SystemX Recessed Ceiling Heater 2kW	480.00
SWD-U-1000-1	Tubular Heater 1kW 110V	666.00	XR-30	SystemX Recessed Ceiling Heater 3kW	546.00
SWD-U-1500-1	Tubular Heater 1.5kW 110V	734.00	XR-60	SystemX Recessed Ceiling Heater 6kW	925.00
SWG-1	Guard For SWD Heaters 450mm	100.00	XS-30	SystemX Surface Mount Heater 3kW	567.00
SWG-2	Guard For SWD Heaters 650mm	126.00	XS-30B	SystemX Surface Mount Heater 3kW - Black	567.00
SWG-3	Guard For SWD Heaters 1075mm	148.00	XS-45	SystemX Surface Mount Heater 4.5kW	609.00
SWG-4	Guard For SWD Heaters 1600mm	238.00	XS-60	SystemX Surface Mount Heater 6kW	806.00
SWG-5	Guard For SWD Heaters 1900mm	247.00			
T16CB	Touch Screen Thermostat - **BLACK**	198.00			
T16CS	Touch Screen Thermostat - Silver	198.00			
T16CW	Touch Screen Thermostat - White	185.00			
THJ	Junction Box IP66 6Way	52.00			
THT	Weatherproof Capillary Thermostat	160.00			
TS-7	Push Button Soft Start Timer 26 Amps	205.00			
TS-7B	Black - Soft Start Timer 26 Amps	205.00			
TS-8	Push Button Timer 26 Amps	207.00			
TS-8B	Black - Push Button Timer 26 Amps	207.00			



01293 547 361



sales@bnthermic.co.uk



07518 574 345